

Fingal County Council



Coastal Erosion Risk Management Study

Portrane - Rush

RPS



Coastal Erosion Risk Management Study: Portrane-Rush

Draft Final Report

DOCUMENT CONTROL SHEET

Client	Fingal County Council					
Project Title	Coastal Erosion Risk Management Study: Portrane-Rush					
Document Title	Draft Final Report					
Document No.	IBE0829/D02					
This Document Comprises	DCS	TOC	Text	List of Tables	List of Figures	No. of Appendices
	✓	✓	✓	✓	✓	

Rev.	Status	Author(s)	Reviewed By	Approved By	Office of Origin	Issue Date
		KC	AKB	AKB	BELFAST	05-12-13

TABLE OF CONTENTS

1	INTRODUCTION.....	1
1.1	BACKGROUND	1
2	SITE DESCRIPTION	2
2.1	PORTRANE	2
2.2	RUSH	2
2.2.1	Rogerstown Estuary	3
2.2.2	Balleally Landfill.....	4
3	PLANNING POLICIES	5
3.1.1	Fingal County Development Plan, 2011-2017.	6
3.1.2	National Development Plan 2007 - 2013.	11
3.1.3	The National Spatial Strategy 2002 - 2020	11
3.1.4	Regional Planning Guidelines for the Greater Dublin Area 2010-2022	11
4	HISTORICAL EVALUATION	14
4.1	BACKGROUND.....	14
4.2	PORTRANE	18
4.2.1	Portrane beach northern section - “Zone 1”	18
4.2.2	Portrane beach central section - “Zone 2”	19
4.2.3	Portrane beach southern section - “Zone 3”	19
4.3	RUSH.....	20
4.3.1	Rush Beach Western End.....	23
4.3.2	Rush Beach Eastern End.....	24
5	WALK OVER SURVEY MAY 2013.....	25
5.1	PORTRANE	25
5.2	RUSH.....	30
6	BEACH TOPOGRAPHIC SURVEY AND SEDIMENT ANALYSIS	34
7	HYDROGRAPHIC SURVEY	38
8	COASTAL PROCESSES AND COASTLINE EVOLUTION.....	39
8.1	BATYMETRY AND COASTAL PROCESS MODEL	39
8.2	TIDAL FLOWS AND LEVELS	42
8.2.1	Tidal flows.....	42
8.2.2	Tidal levels.....	42
8.3	OFFSHORE WAVE AND WIND DATA.....	45
8.3.1	Extreme waves.....	50
8.3.2	Extreme wind.....	51
8.4	JOINT PROBABILITY ANALYSIS.....	52
8.5	INSHORE WAVE CLIMATE.....	54
8.6	LITTORAL CURRENTS AND SEDIMENT TRANSPORT.....	59

8.6.1	Overall Sediment Transport Regime	59
8.6.2	Littoral Current and Sediment Transport Simulations	59
8.6.3	Aeolian Transport	61
8.7	SEA LEVEL RISE AND ASSOCIATED IMPACTS	62
9	CURRENT AND FUTURE SCENARIO COASTAL CHANGE MAPS.....	64
9.1	PORTRANE	64
9.2	RUSH	66
10	RISK ASSESSMENT	67
10.1	PORTRANE	69
10.2	RUSH	72
11	ENVIRONMENTAL ASSESSMENT	73
11.1	NATURA 2000 SITE AND THEIR CONSERVATION OBJECTIVES	73
11.2	ROGERSTOWN ESTUARY SAC.....	73
11.3	ROGERSTOWN ESTUARY SPA.....	76
12	OPTIONS AND FEASIBILITY ASSESSMENT	79
12.1	INTRODUCTION	79
12.2	THE 'DO NOTHING' SHORELINE OPTION.....	81
12.2.1	Short term impacts (year 2015).....	81
12.2.2	Medium term impacts (year 2050).....	82
12.2.3	Long term impacts (year 2100)	82
12.3	PRELIMINARY OPTIONS APPRAISAL.....	83
12.3.1	Options short-listed for Appraisal	85
12.4	EVALUATION OF STRATEGIC OPTIONS.....	87
12.5	IDENTIFICATION OF THE PREFERRED OPTIONS.....	93
12.5.1	Zone 1, Northern Portrane Beach	93
12.5.2	Zone 2 Section 2.1, Middle Portrane Beach	95
12.5.3	Zone 2 Section 2.2, Middle Portrane Beach	97
12.5.4	Zone 3 Section 3.1, Southern Portrane Beach	99
12.5.5	Zone 3 Section 3.2, Southern Portrane Beach	102
12.6	SPECIFICATION OF PROPOSED OPTIONS	104
12.7	SOFT ENGINEERING: SAND TRAP FENCING.....	104
12.7.1	General.....	104
12.7.2	Fencing Details.....	106
12.7.3	Fencing Design.....	106
12.7.4	Potential Problems	107
12.7.5	Environmental impacts and opportunities	107
12.7.6	Costs	107
12.8	SOFT ENGINEERING: DUNE REPROFILING AND MARRAM PLANTING.....	108
12.8.1	General.....	108
12.8.2	Environmental impacts and opportunities	110

12.8.3	Costs	110
12.9	SOFT ENGINEERING: PERIODIC MAINTAINCE OF DEFENCES	110
12.10	HARD ENGINEERING: REVETMENT AND BURIED “LONG STOP”	111
12.10.1	Revetments	111
12.10.2	Buried Long stop	111
13	ECONOMIC ASSESSMENT	113
13.1	INTRODUCTION	113
13.1.1	General approach.....	113
13.1.2	Discounting.....	113
13.2	BENEFITS	113
13.3	COSTS	116
13.3.1	Initial capital costs	116
13.3.2	Annual and Periodic Maintenance.....	117
13.3.3	Annual and Periodic Maintenance.....	117
13.3.4	Benefit cost ratios.....	119
14	CONCLUSIONS AND RECOMMENDATIONS	120
14.1	CONCLUSIONS	120
14.1.1	Historical Review	120
14.1.2	Coastal Processes	120
14.1.3	Impact of Climate Change.....	121
14.1.4	Environmental Designated Areas.....	121
14.1.5	Option and Feasibility Assessment.....	121
14.2	RECOMMENDATIONS	122
15	REFERENCES	1

LIST OF FIGURES

Figure 1.1.1: Study Location.....	1
Figure 2.2.1: Aerial view of the study area (2009) <i>Aerial image © ESRI/Bing Maps 2013</i>	3
Figure 4.1.1: Historical changes in high water mark	15
Figure 4.1.2: Portrane - vegetation lines from OS aerial photos superimposed on 1973 photograph..	16
Figure 4.1.3: Portrane - vegetation lines from OS aerial photos superimposed on 2009 photograph..	17
Figure 4.2.1: “Zones” of erosion/accretion on Portrane beach.....	18
Figure 4.3.1: Rush - vegetation lines from OS aerial photos superimposed on 1973 photograph	21
Figure 4.3.2: Rush - vegetation lines from OS aerial photos superimposed on 2009 photograph	22
Figure 4.3.3: “Zones” of erosion/accretion on Rush beach	23
Figure 5.1.1: Accreting area at northern end of Portrane (view north).....	25
Figure 5.1.2: view south from northern end of Portrane beach (accreting area)	26
Figure 5.1.3: Dune growth area, mid beach (looking north).....	26
Figure 5.1.4: Eroding area, southern end of beach (looking north)	27
Figure 5.1.5: Erosion damage, southern end of beach (looking north)	27
Figure 5.1.6: Wooden boardwalk with erosion damage, south end of beach (looking north)	28
Figure 5.1.7: Wooden boardwalk view south showing erosion protection sandbags.....	28
Figure 5.1.8: Sandbags at southern end of the beach	29
Figure 5.1.9: Erosion around southern bathing beach access area	29
Figure 5.1.10: Southernmost end of Portrane beach, looking north	30
Figure 5.2.1: Rush boat club erosion and undermining	30
Figure 5.2.2: Rush golf club area erosion	31
Figure 5.2.3: Accretion at eastern end Rush Golf Club.....	31
Figure 5.2.4: Rush bathing area, view east.....	32
Figure 5.2.5: Rush eastern end bathing area – stable/accreting vegetation.....	32
Figure 5.2.6: Rush eastern end bathing area, rock armour	33
Figure 5.2.1: Location of Sediment Sampling Stations	34
Figure 5.2.2: Sediment Grading Curves, samples from Rush North.....	35
Figure 5.2.3: Sediment Grading Curves, samples from Rush Centre.....	35
Figure 5.2.4: Sediment Grading Curves, samples from Rush South	36
Figure 5.2.5: Sediment Grading Curves, samples from Portrane North	36
Figure 5.2.6: Sediment Grading Curves, samples from Portrane Centre	37
Figure 5.2.7: Sediment Grading Curves, samples from Portrane South.....	37
Figure 5.2.1: Figure 7.1: Area covered by the 2013 Hydrographic Survey	38
Figure 8.1.1: Extent and bathymetry of Irish Sea tidal and Storm Surge model.	40
Figure 8.1.2: Extent and bathymetry of the outer Portrane model.	40
Figure 8.1.3: Extent and bathymetry of the inner Portrane model.	41
Figure 8.1.4: Computational Mesh of the inner Portrane model	41

Figure 8.2.1: The tidal regime - Spring Mid Flood.....	43
Figure 8.2.2: The tidal regime - Spring high Water.....	43
Figure 8.2.3: The tidal regime - Spring Mid Ebb.....	44
Figure 8.2.4: The tidal regime - Low Water.....	44
Figure 8.3.1: Wave Rose of the offshore wave climate at the point 53.5° N 5.50° W, 1997-2011.....	46
Figure 8.3.2: Wave Rose of Significant Wave Heights above 1.5m for the offshore point 53.5° N 5.50° W, 1997-2011.....	47
Figure 8.3.3: Wind Rose of the offshore wind climate at the point 53.5° N 5.50° W, 1997-2011.....	48
Figure 8.3.4: Wind Rose of the offshore wind climate above 12 m/s at the point 53.5° N 5.50° W, 1997-2011.....	49
Figure 8.4.1: Joint Probability Curves, Extreme Waves and Water Levels.....	53
Figure 8.5.1: The inshore wave climate at Portrane beach – 15 year period 1997-2011.....	55
Figure 8.5.2: The inshore wave climate at Rush beach – 15 year period 1997-2011.....	56
Figure 8.6.1: SE Gale - littoral currents and sediment transport at high water.....	60
Figure 8.6.2: SE Gale - littoral currents and sediment transport at mid ebb.....	60
Figure 8.6.3: SE Gale - littoral currents and sediment transport at mid flood.....	60
Figure 8.7.1: Significant wave height and mean wave direction 1 in 50 year return period event at 2013 water levels.....	62
Figure 8.7.2: Significant wave height and mean wave direction 1 in 50 year return period event at 2100 water levels with 0.5m sea level rise.....	63
Figure 8.7.3: Significant wave height and mean wave direction 1 in 50 year return period event at 2100 water levels with 1.0m sea level rise.....	63
Figure 9.1.1: Current and future scenario vegetation lines for Portrane Beach.....	65
Figure 9.2.1: Current and future scenario vegetation lines for Rush Beach.....	66
Figure 9.2.1: Zones 2 and 3 of Portrane beach were further divided into sub sections for the Risk Assessment.....	68
Figure 10.1.1: Properties identified as being at risk in Zone 2 of Portrane Beach.....	70
Figure 10.1.2: Properties identified as being at risk in Zone 3 of Portrane Beach.....	71
Figure 11.2.1: Rogerstown Estuary SAC and SPA boundaries.....	74
Figure 12.7.1: Sand trap fencing being employed successfully at Co. Clare.....	105
Figure 12.7.2: Sand trap fencing damage following typical winter storm event Co. Clare.....	105
Figure 12.7.3: Wind Rose for Dublin Airport.....	106
Figure 12.7.4: Sand trap fencing design recommendations from ECOPRO Manual.....	108
Figure 12.8.1: Over steepened dunes, southern Portrane beach.....	109
Figure 12.8.2: Sketch of typical marram planting and fencing.....	109
Figure 12.10.1: Buried “Long Stop” installed to protect a property behind the dune line.....	112

LIST OF TABLES

Table 2.2.1:CSO Ireland Census Populations of Rush and Portrane 1996-2011	2
Table 8.3.1: Return periods for significant waves between 0 and 30 Degrees	50
Table 8.3.2: Return periods for significant waves between 180 and 210 Degrees	50
Table 8.3.3: Return periods for Wind Velocities between 0 and 30 Degrees	51
Table 8.3.4: Return periods for Wind Velocities between 180 and 210 Degrees	51
Table 8.4.1: Derived Correlation between Offshore Waves and water Levels	52
Table 11.2.1: Natura 2000 sites Located within the Zone of Influence of the proposed interim measures, Conservation Interests and Vulnerability/ Threats.....	75
Table 11.2.2: Qualifying Features and Conservation Objectives for Designation of Rogerstown Estuary SAC	76
Table 11.3.1: Qualifying Features and Conservation Objectives for Designation of Rogerstown Estuary SPA.....	77
Table 11.3.2: Rogerstown Estuary SPA Conservation Objectives.....	78
Table 12.1.1:Initial review of Coastal Protection policies for Portrane	80
Table 12.3.1: Appraisal of long list of options.....	83
Table 12.3.2: Short-listed options for appraisal.....	85
Table 12.4.1: Multi-Criteria Analysis of coastal management options for Portrane Beach, Zone 1.....	88
Table 12.4.2: Multi-Criteria Analysis of coastal management options for Portrane Beach, Zone 2 – Section 2.1.....	89
Table 12.4.3: Multi-Criteria Analysis of coastal management options for Portrane Beach, Zone 2 – Section 2.2.....	90
Table 12.4.4: Multi-Criteria Analysis of coastal management options for Portrane Beach, Zone 3 – Section 3.1	91
Table 12.4.5: Multi-Criteria Analysis of coastal management options for Portrane Beach, Zone 3 – Section 3.2.....	92
Table 12.5.1: Implications of coastal management options for Portrane Beach, Zone 1	94
Table 12.5.2: Implications of coastal management options for Portrane Beach, Zone 2 – Section 2.1	96
Table 12.5.3: Implications of coastal management options for Portrane Beach, Zone 2 – Section 2.2	98
Table 12.5.4: Implications of coastal management options for Portrane Beach, Zone 3 – Section 3.1	100
Table 12.5.5: Implications of coastal management options for Portrane Beach, Zone 3 – Section 3.2	103
Table 13.2.1: Predicted year of losses of properties at risk from erosion, assuming HEFS climate changes.	114
Table 13.2.2: Calculation of asset losses and benefits of a proposed protection scheme	115
Table 13.3.1: The initial capital costs of the proposed management options	116
Table 13.3.2: The assumed capital maintenance costs of the proposed management options	117
Table 13.3.3: A summary of options total Present Value (PV) Costs including maintenance.	118

Table 13.3.4: Benefit cost ratios for each Strategy Zone and Section 119

APPENDICES

A: Historical Photographs

B: Sediment Analyses

C: Coastal Processes

D: Conservation Objectives

E: Weighting of MCA Criterion

1 INTRODUCTION

1.1 BACKGROUND

The coastline of Portrane and Rush in North County Dublin is a dynamic ecosystem. The beach and dune systems on either side of the mouth of the Rogerstown Estuary are part of one hydrogeological system, reflected in the simultaneous growth and decline of the expanse of the beaches and the extent of the dunes. Sedimentation and erosion processes seem to occur on a cyclical basis within this sub cell of the Irish Sea.

Erosion at The Burrow has been a concern for a number of decades. In the late 1990s, studies were undertaken to provide coastal protection options for the coastline at the northern end of the Burrow. At present, the southern end of the beach is the area causing greatest concern. In recent years, coastal erosion has accelerated and the sea is starting to get closer to private property near the beach. Erosion is also occurring along the beach at Rush.

The local community and Fingal County Council are keen to find out what measures can be taken to prevent any damage to private and public property at the southern end of the Burrow, while also establishing what erosion and sedimentation processes and patterns are taking place on a wider scale in the overall area.

Fingal County Council appointed consultants RPS to undertake a detailed coastal erosion risk management investigation and to develop an appropriate plan to best manage the risks identified to human health, the environment, cultural heritage and economic activity at this location. The study will provide baseline information on erosion and sedimentation patterns at Portrane and Rush and how these patterns could be affected as a result of coastal protection measures. The predicted effects of future climate change scenarios are also to be incorporated into the study.



Figure 1.1.1: Study Location

2 SITE DESCRIPTION

2.1 PORTRANE

The Burrow, Portrane is a sandy spit that separates the outer Rogerstown Estuary from the Irish Sea (Figure 1.1.1 and Figure 2.2.1). The area is extensively used for recreation and is of significant environmental importance, holding a number of National and European designations. The spit is protected by a wide sandy beach that is itself, bordered by rock headlands at Rush to the north and Portrane to the south.

The nature of the spit and beach is strongly influenced by the tidal action of the estuary, combining with the waves approaching the shoreline from the Irish Sea. Lambay Island, which lies around 5km east of the beach, also influences both the wave and tidal conditions.

The beach at Portrane is around 1.8km long, with a bathing area at its southern end that has been awarded Blue Flag status. It is a popular recreational and amenity location for the public and tourists throughout the year and has lifeguards present during the summer season.

Portrane (2011 population 1,372) is adjacent to the larger agglomeration of Donabate and in the Fingal development plan is considered as a small town. The decline in population of Portrane shown in Table 2.2.1 below is the result of a major reduction in the institutional population of a large hospital, which has been subject to a gradual phasing out of residential care over the past two decades. The former hospital is now a site earmarked for redevelopment so the area may see a rise in population in coming years. The environmental sensitivity of the Burrow area is recognised in the Local Development Plan (2011-17) and sustainable development is encouraged, alongside the gradual removal of temporary mobile homes, huts and wooden chalets that are common at the site and often accompanied by poor waste water infrastructure. The replacement of temporary accommodation with permanent dwellings is also discouraged in the local development plan.

In response to concerns of coastal erosion at the beach, a series of monitoring posts have been installed on the upper beach to enable accurate measurement of coastal erosion and accretion.

2.2 RUSH

Rush was formerly a centre for horticulture and agriculture and indeed cloches or greenhouses are very evident in many of the earlier aerial photographs presented below and in *Appendix A*. However, with the emergence of the “Celtic Tiger” and the accessibility of the new M1 motorway in the late 2000s, the area became sought after as a commuter area and many of the areas formerly given to agriculture and horticulture were sold for development. This is reflected in the increasing population statistics presented below in Table 2.2.1, which show that the local population has risen by 60% over the 15 year period between 1996 and 2011.

Table 2.2.1: CSO Ireland Census Populations of Rush and Portrane 1996-2011

Population	Rush	% change	Portrane	% change
1996	5,429	-	1,924	-
2002	6,769	+24.6	1,726	-10.2
2006	8,286	+22.4	1,532	-11.2
2011	9,231	+11.4	1,372	-10.4

The beach at Rush is approximately 2.4km in length and is mainly backed by dunes and a 9-hole golf links course. In the past the bathing area at the eastern end of the beach has been awarded blue flag and green coast awards. However, failure to comply with the EU mandatory values for *E.coli* in 2012 caused these awards to be removed for the 2013 season.



Figure 2.2.1: Aerial view of the study area (2009) Aerial image © ESRI/Bing Maps 2013.

As evidenced in the aerial photographs (Figure 2.2.1), vehicles were formerly permitted to drive and park on the beach at Rush, however all of the Fingal beaches were closed to vehicles (except emergency vehicles and traders licensed by the council) in 2009.

The beaches at Portrane and Rush and the estuary waters are of significant environmental importance, holding the European level designations of Special Area of Conservation (SAC) and Special Protection Area (SPA) in addition to the national level designation of proposed Natural Heritage Area (pNHA).

2.2.1 Rogerstown Estuary

Rogerstown Estuary is a relatively small, narrow estuary separated from the sea by a sand and shingle bar. The estuary drains almost completely at low tide and is divided by a causeway and narrow bridge, built in the 1840s to carry the Dublin-Belfast railway line. The intertidal flats of the outer estuary are mainly of sands, with soft muds in the north-west sector and along the southern shore. The area of intertidal flats in the inner estuary is reduced as a result of the local authority refuse tip on the north shore. The sediments are mostly muds that are very soft in places. The Ballough and Ballyboghill rivers flow into the estuary to the west of the railway bridge and drain an area of approximately 77 square kilometres.

Due to the constriction of tidal flow between the inner and outer sections of the estuary caused by the viaduct, drainage from the inner estuary continues for 2-3 hours after low tide. Salt marsh fringes parts of the estuary, especially the southern shores and parts of the outer sand spit. Salt marsh in the upper regions of the inner estuary is only covered significantly during higher spring tides.

Low sand hills occur on the outer spit, including some small areas of fixed dunes and *Ammophila* dunes. Fine sandy beaches and intertidal sandflats occur at the outer part of the estuary.

In addition to the national and European designations outlined above, the outer estuary is also classified as a Ramsar wetland of international importance and a statutory Nature Reserve.

Rogerstown Estuary has gained its nature conservation designations through its importance as a site for wildfowl, hosting internationally important numbers of Brent Geese in winter, as well as nationally important wintering populations of 16 other species. The estuary has also been known to attract breeding terns in summer, however many of the nesting sites have been lost through erosion (NPWS, 2000). It hosts several habitats listed on Annex I of the Habitats Directive, including "Estuaries", "Mudflats and sandflats not covered by seawater at low tide", Salt marsh habitats and dune habitats including the priority habitat "Fixed coastal dunes with herbaceous vegetation ('grey dunes)". Two plant species that are legally protected under the Flora (Protection) Order, 1999, occur within the site: Hairy Violet (*Viola hirta*) occurs on the sand spit and Meadow Barley (*Hordeum secalinum*) occurs in the saline fields of the inner estuary. This species has declined apparently due to reclamation and embankment of lands fringing the estuaries. Another rare species, Green-winged Orchid (*Orchis morio*), occurs in the sandy areas of the outer estuary.

2.2.2 Balleally Landfill

Balleally Landfill is situated on an area of reclaimed land which encroaches into the Rogerstown Estuary. It has been operated by Fingal County Council since 1971 and was formerly the largest landfill in the Dublin Region, accepting all waste generated within Fingal County Council's administrative area as well as waste from Dublin Corporation and South Dublin County Council. It closed to general waste in 2012, however soil and construction and demolition waste are still accepted for restoration purposes. The restoration works consist of capping the landfill cells with artificial liner (polyethelene and bentonite materials) and soil, followed by landscaping of the finished profile.

The landfill was originally designed on the 'dilute and disperse' principle, with no leachate containment measures, which is typical of landfills established in the 1970s in Ireland. Leachate from the landfill is now collected and treated at an on-site leachate treatment plant but it is not permitted to be discharged into the estuary. Instead, the treated leachate is tankered to Ringsend and treated at the WWTP there to the required standards for discharge. Fingal County Council previously applied to the EPA for permission to discharge the leachate directly into the estuary but an Appropriate Assessment conducted on the plan considered that the proposal may have the potential to have significant impacts on the Natura 2000 sites. Fingal County Council is now examining the possibility of constructing a new 800m pipeline to connect the leachate treatment plant at Balleally to the sewer network at Rogerstown Lane for transport and treatment to Portrane WWTP, which would avoid the need for tankering.

3 PLANNING POLICIES

The role of the coastal management plan was reviewed with regard to relevant planning and environmental policy. The following documents were consulted during this process:

Fingal Development Plan 2011-2017.

National Development Plan (Transforming Ireland – A Better Quality of Life for All), 2007-2013

The National Spatial Strategy, 2002–2020

Regional Planning Guidelines for The Greater Dublin Area 2010-2022

The key strategic objectives and aims of the above policy documents are summarised as follows:

- to preserve and improve amenities;
- to foster balanced Regional Development;
- to enhance and promote a high quality environment;
- Invest in long-term environmental sustainability to achieve our national goal of preserving the integrity of our natural environment for future generations as well as meeting our international responsibilities and Climate Change obligations; this also involves a more balanced, efficient and sustainable use of our land resources;
- to meet the future development needs of the community;
- to accommodate change, while maintaining the character of the countryside;
- to promote a high quality design in new development;
- to pursue conditions and standards, which will be beneficial not only to specific areas but to the entire country;
- to ensure that nature conservation policies contribute to conservation of the abundance and diversity of the Irish wildlife and its habitats;
- to minimise the adverse effects on wildlife, where conflict of interest is unavoidable; and
- to meet international responsibilities and obligations for nature conservation.

Taking each of the policy documents in turn, the following specific references to issues relating to this development were noted.

3.1.1 Fingal County Development Plan, 2011-2017.

With the increasing threats to property and infrastructure posed by coastal erosion and flooding on the east coast and the associated work being undertaken by the Irish Coastal Protection Strategy (ICPS) and the Eastern Catchment Flood Risk Assessment and Management (CFRAM), the most recent version of the County Development Plan has carefully considered the pressures and requirements on development within the coastal zone area.

It is acknowledged in the development plan under section 5.5 that the coast is an ever changing dynamic environment, subject to the continuous natural processes of erosion and deposition. While erosion is a normal occurrence in coastal areas, rates of erosion may be accelerated due to storm action, inappropriate development, pressures from leisure or recreational activities or the presence of man-made protection works.

In addition, the impacts of predicted sea level rise due to climate change need to be considered. The predicted increase in the frequency of storm surges and high tides will increase the extent, severity and recurrence of coastal flooding and may also lead to increased rates of coastal erosion.

The plan also states that there is a strong case for restricting and containing development near the coast now, so that we protect areas of soft coastline and associated soft defences into the future. Development along the coast must recognise the need for coastal protection in all instances and the role that coastal habitats such as beaches, salt marshes and sand-dunes play in this. Retaining and enhancing these elements, and providing space for associated natural processes to take place, provides a sustainable and cost-effective alternative to the provision of hard coastal defences.

The Development Plan has set out a number of objectives relating to coastal processes:

Objective CT01

- Ensure the County's natural coastal defences, such as beaches, sand dunes, salt marshes and estuary lands, are protected and are not compromised by inappropriate works or development.

Objective CT02

- Employ soft engineering techniques as an alternative to hard coastal defence works, wherever possible.

Objective CT03

- Identify, prioritise and implement necessary coastal protection works subject to the availability of resources, whilst ensuring a high level of protection for natural habitats and features, and ensure due regard is paid to visual and other environmental considerations in the design of any such coastal protection works.

Objective CT04

- Protect the special character of the coast by preventing inappropriate development along the coast, particularly on the seaward side of coastal roads.

Objective CT05

- Ensure that developments along the coast are sited and designed appropriately having regard to the visual impact on the visual compartment(s) within which they are located.

Objective CT06

- Foster development in coastal areas that primarily meets the needs of local communities and local enterprises. Development should be in keeping with the character of the local area and have the necessary infrastructure (e.g. roads, sewerage) provided. It should not damage or degrade and, where possible, it should enhance the environment, heritage and landscape of the area.

Objective CT07

- Designate a Coastal Zone, during the lifetime of the Plan, to provide for the proper planning and sustainable development of the coast, while protecting its landscape and seascape character, its unique natural and cultural heritage, its amenities and economic value, and its role in coastal defence.

Objective CT08

- Undertake a Seascape Assessment to aid in the designation of a Coastal Zone and in the establishment of sustainable levels of social and economic activities in coastal areas.

Objective CT09

- Promote, support and facilitate coastal zone management initiatives in partnership with the local community, environmental groups, user organisations and statutory authorities, including adjoining local authorities.

Objective CT10

- Protect the sensitive nature of the coastal zone. New development for which a coastal location is required shall, wherever possible, be accommodated within existing developed areas.

Objective CT11

- Strictly control the nature and pattern of development within coastal areas and ensure that it is designed and landscaped to the highest standards, and sited appropriately so as not to detract from the visual amenity of the area. Development shall be prohibited where the development poses a significant or potential threat to coastal habitats or features, and/or where the development is likely to result in altered patterns of erosion or deposition elsewhere along the coast.

Objective CT12

- Prohibit development along the coast outside existing urban areas where such development could not be adequately safeguarded over the lifetime of the development without the need to construct additional hard coastal defences.

Objective CT13

- Prohibit new development outside urban areas within the areas indicated on Green Infrastructure maps, which are within 100m of coastline at risk from coastal erosion, unless it can be objectively established based on the best scientific information available at the time of the application, that the likelihood of erosion at a specific location is minimal taking into account, inter alia, any impacts of the proposed development on erosion, or deposition.

Objective CT14

- Prohibit development within areas liable to coastal flooding other than in accordance with *The Planning System and Flood Risk Management – Guidelines for Planning Authorities (2009)* issued by the Department of the Environment, Heritage and Local Government and the Office of Public Works.

Objective CT15

- Establish a coastal monitoring programme to provide information on coastal erosion on an ongoing basis.

Objective CT16

- Encourage leisure and amenity type uses along the coast so long as such uses do not cause significant adverse impacts on the environment, visual amenity and heritage.

Objective CT17

- Ensure the implementation of site specific management policies to ensure that erosion and flooding is not initiated or aggravated by the impact of human activity, e.g. motorised forms of water sports.

Objective CT18

- Identify locations along the coast, during the lifetime of the Development Plan, where recreational/tourist activities can best be accommodated having regard to the dynamic nature of coastal processes and the need to protect and enhance natural and cultural heritage, visual amenity, the environment and the character of the coast. As a corollary, locations will be identified where this type of development should not occur.

Objective CT19

- Plan and develop the Fingal Coastal Way from north of Balbriggan to Howth taking full account of the need to protect the natural and cultural heritage of the coast and the need to avoid significant adverse impacts on Natura 2000 sites, other protected areas and species protected by law.

Objective CT20

- Ensure that there is appropriate public access to the coast including the provision of coastal walkways and cycleways, while taking full account of the need to conserve and enhance the natural and cultural heritage of the coast and the need to avoid significant adverse impacts on Natura 2000 sites and species protected by law, and examine the designation of traditional walking routes thereto as public rights of way.

Objective CT21

- Encourage the development of facilities for maritime leisure developments where the siting of such installations and their supporting infrastructure will not have a significant adverse impact on the natural or cultural heritage or detract from the visual amenity and environmental quality and stability of an area, or public access to beaches.

Objective CT22

- Ensure that all proposed recreation/tourist facilities and other maritime leisure developments are accessible for pedestrians and cyclists and take advantage of sustainable transport alternatives through provision of pathways, cycleways and links to the public transport system.

The plan also notes that: *“The coastal zone is subject to growing pressures from increasing population and increasing and sometimes conflicting social, economic and recreational uses. The coastline in particular has always been perceived as an attractive place to live. As the population of the County increases, the demands made on the coastline, its habitats and waters will grow. As a general principle, development in coastal areas should be accommodated wherever possible in previously developed areas before consideration is given to development in greenfield sites.*”

In all cases proposals for coastal development must consider the need for coastal defence. Development will only be permitted where the Council is satisfied that the development will not add to the requirement, if any, for hard coastal defence works in the area over the lifetime of the development.”

In terms of specific development strategies for Portrane and Rush, selected objectives are also included below:

Objective Portrane 1

- Provide recreational facilities for the expanding population on the peninsula subject to HDA Screening.

Objective Portrane 4

- Ensure the sensitive coastal estuarine area of the Burrow is adequately protected and that any proposed development is subject to an HDA screening.

Objective Portrane 5

- Prohibit the replacement of chalets/holiday huts by permanent dwellings, which can be resided in on an all year basis within the 'HA' zoned land at The Burrow, and encourage the removal of existing chalets and huts at The Burrow.

Objective Rush 4

- Preserve and improve the coastal amenities of Rush including the creation of a coastal walkway from Rogerstown Estuary to Rush Harbour as part of the Fingal Coastal Way subject to an Appropriate Assessment screening.

Objective Rush 10

- Prepare and implement the Rogerstown Estuary Management Plan, and subject the Management Plan to Habitats Directive Assessment prior to its adoption.

Objective Rush 11

- Prepare a Masterplan for the development of marina and water sports facilities at Rush Sailing Club with improved access and off street parking to serve the local community subject to an Appropriate Assessment.

Beaches and their associated bathing waters provide a unique natural resource that offers a high value leisure environment.

Objective CT28

- Protect beaches, access to beaches and designated bathing areas as valuable local amenities and as a tourism resource.

Objective CT29

- Protect bathing waters, including those listed in the Water Framework Directive Register of Protected Areas for the Eastern River Basin District, at Sutton, Portmarnock, Malahide, Donabate, Portrane, Rush, Loughshinny, Skerries and Balbriggan in order that they meet the required bathing water standards and implement the findings and recommendations of the Quality of Bathing Water in Ireland reports as published.

3.1.2 National Development Plan 2007 - 2013.

The National Development Plan (NDP) recognises that many areas of Ireland face problems of coastal erosion and flooding. The NDP recognises that the Irish coastline contains a wealth of resources, of economic, social, cultural, environmental and nature conservation value. In recent years it has been accepted that the coastline is a valuable natural resource that needs careful and sensitive management. A sub-programme has been set with responsibility over maintaining and supporting Ireland's eroding coastlines and some €23 million will be spent under this Sub-Programme to protect the coastline from erosion and manage the problem of coastal flooding to minimise its impact on the commercial and social activities of coastal communities. Within the NDP the objective of this protection programme is *"to ensure the sustainable development and management of the marine coastal zone by addressing priority coast protection requirements"*.

The Plan acknowledges that the environmental impacts of projects undertaken under the Coastal Protection Sub-Programme are largely positive. Project design and planning takes full account of environmental, ecological and heritage issues. Environmental Impact Assessments are undertaken for schemes that are likely to have a significant impact in environmental terms. All necessary statutory consents are obtained prior to works commencing.

3.1.3 The National Spatial Strategy 2002 - 2020

The National Spatial Strategy (NSS) is a coherent national planning framework for Ireland for the next 20 years. The NSS aims to achieve a better balance of social, economic and physical development across Ireland, through more effective planning policy. The National Development Plan has been formulated in accordance with the NSS, specifically through a chapter on balanced regional development. Within the NSS, this relates to coastal development through the following:

- The sustainable development of the marine and natural resources sectors has a key role to play in supporting and advancing the economic well being of rural and coastal areas. It is of particular importance for peripheral coastal communities. The following spatial issues arise:
 - Coastal infrastructure, commensurate with the needs of the seafood and marine leisure sectors, at strategic ports and other key locations of particular importance for local economies must be developed.
 - An appropriate balance must be struck between the wide range of economic, leisure and amenity activities and uses in coastal and island areas.
 - Access infrastructure appropriate to the requirements of these sectors and the areas in which they operate is needed.

3.1.4 Regional Planning Guidelines for the Greater Dublin Area 2010-2022

A regional approach to integrated coastal zone management (ICZM) is supported by the NSS and recommended by the EU. The ICZM model offers a means to sustainably manage the development of the coastal zone through a collaborative and community focussed approach to planning and management of coastal resources. It is also concerned with the promotion of sustainable marine focused tourism and leisure activities, and protection of marine and coastal environments.

A balance must be struck between the wide range of activities possible. This balance includes the requirements of provisions for recreation, public slipways and marina activity against international and national obligations to protect and responsibly manage designated cultural and natural heritage coastal areas. Globally, marine environments are experiencing growing pressure from increasing populations along the coast; infrastructural and recreational development within coastal areas; the necessary building of flood defences causing a coastal squeeze on marine habitats; the effects of climate change (flooding, increases in invasive species, and reduction in ocean salinity); and pollution from land side agricultural and industrial activities.

Coastal erosion and flooding has the potential to affect properties, businesses and infrastructure and can lead to loss of coastal archaeology and sites of architectural or tourism importance. ICZM needs to address this issue looking at:

- (i) precautionary approaches should be taken including the creation of buffer zones to restrict development within areas of high risk erosion, predicted sea level increase or high coastal flooding risk and
- (ii) suitable sustainable options for protecting key assets- natural, built and infrastructure; and a full exploration of all the issues including habitat impact, through the preparation of Coastal Zone Management Plans with local authorities, state bodies and communities working together. The completion of the Catchment Flood Risk Assessment and Management Studies (CFRAMS) and the Irish Coastal Protection Strategy will also provide valuable information to local authorities on flood risk in coastal areas, which can input into future Coastal Zone Management Plan.

Section 7.5.1 of the guidelines includes the following policies and recommendations

Strategic Policy GIP4

- Promote the development of cross boundary Integrated Coastal Zone Management with all coastal local authorities in the GDA area so that future Development Plans can be guided in relation to the management of coastal areas drawing from a mutually supported plan for marine and coastal areas that has engaged with key stakeholders.

Strategic Recommendations:

- GIR22 The completion of an ICZM for Dublin Bay, building on research and the completion and implementation of the recommendations of the Dublin Bay Taskforce and working collaboratively to achieve an agreed framework plan or strategy incorporating land and marine planning and policies in an integrated manner and with regard to Article 6 of the Habitats Directive.
- GIR23 The expansion of collaborative ICZM, and consideration of the complementary process and framework of marine spatial planning, for similar cohesive coastal landscape blocks to Dublin Bay along the eastern seaboard.

This process shall take account of the:

- Water Framework Directive,
 - Birds Directive,
 - Marine Strategy Framework Directive,
 - Flood Risk Assessment studies,
 - Article 6 of the Habitats Directive,
 - Best available information on the regional impacts of climate change and
 - All current and future alignments between these directives, assessments, and plans.
- GIR24 That the concept of coastal parks is considered in future planning as a means of enhancing coastal habitats marine protection and sustainable marine based tourism and of integrating coastal (blue) infrastructure with green infrastructure.

Any proposed scheme at Portrane or Rush should be consistent with the objectives of the plans outlined above. Development should make a positive contribution to fulfilling the strategic objectives of the policy documents in a manner consistent with present planning and environmental policies.

4 HISTORICAL EVALUATION

4.1 BACKGROUND

In the previous study of the Burrow, Portrane, undertaken by Kirk McClure Morton in 1998, historical changes in the coastline at the north end of the Burrow were also assessed by reference to Ordnance survey maps of 1842 and 1938, together with an aerial survey in 1971 and a 1997 beach survey. These comparisons are shown overleaf in Figure 4.1.1 to Figure 4.1.3.

In order to better understand the more recent coastal processes operating at Portrane and Rush beaches, a review has been undertaken of historical aerial ortho photographs acquired from the Ordnance Survey Ireland. The aerial photographs were taken in 1973, 1982 (showing Portrane only), 1995, 2000, 2005, 2009 and 2011 provide a degree of insight into the evolution of the beach over the past 40 years.

Each photograph was accurately geo referenced using ArcGIS and the vegetation line (i.e. the boundary of where visible vegetation growth is observed on the upper beach) was digitised. The 1973 photograph and 2009 photograph with the other years' vegetation superimposed are presented in Figure 4.1.2 and Figure 4.1.3 respectively for Portrane, and Figure 4.3.1 and Figure 4.3.2 respectively for Rush. All of the photographs used in the study are presented in *Appendix A*.

It can be seen in Figure 4.1.1 that the changes in the high water mark at Portrane suggest that there was erosion at the southern end of the Burrow between 1843 and 1938 and a substantial accretion at the northern end during the same period. Between 1938 and 1971 there appears to be considerable erosion at the north eastern end of the Burrow.

However, analysis of the high water mark is not always a reliable measure for erosion rates as the definition of the high water mark may not always be consistent and a minor change in beach level can account for a substantial movement of the high water mark. The aerial photos provide a more accurate means of assessment, although they cover a much shorter timescale.

In general, the aerial photos in Figure 4.1.2 and Figure 4.3.1 and in *Appendix A* show that both beaches experience episodes of both erosion and accretion over the past 40 years, reflecting a dynamic beach system that moves in response to changes in prevailing weather conditions. While there has been movement of the dune line in both easterly and westerly directions on both beaches, it is notable that in almost all areas of both coastlines the 2013 vegetation line has not retreated any further west than that seen in the photos of previous years.

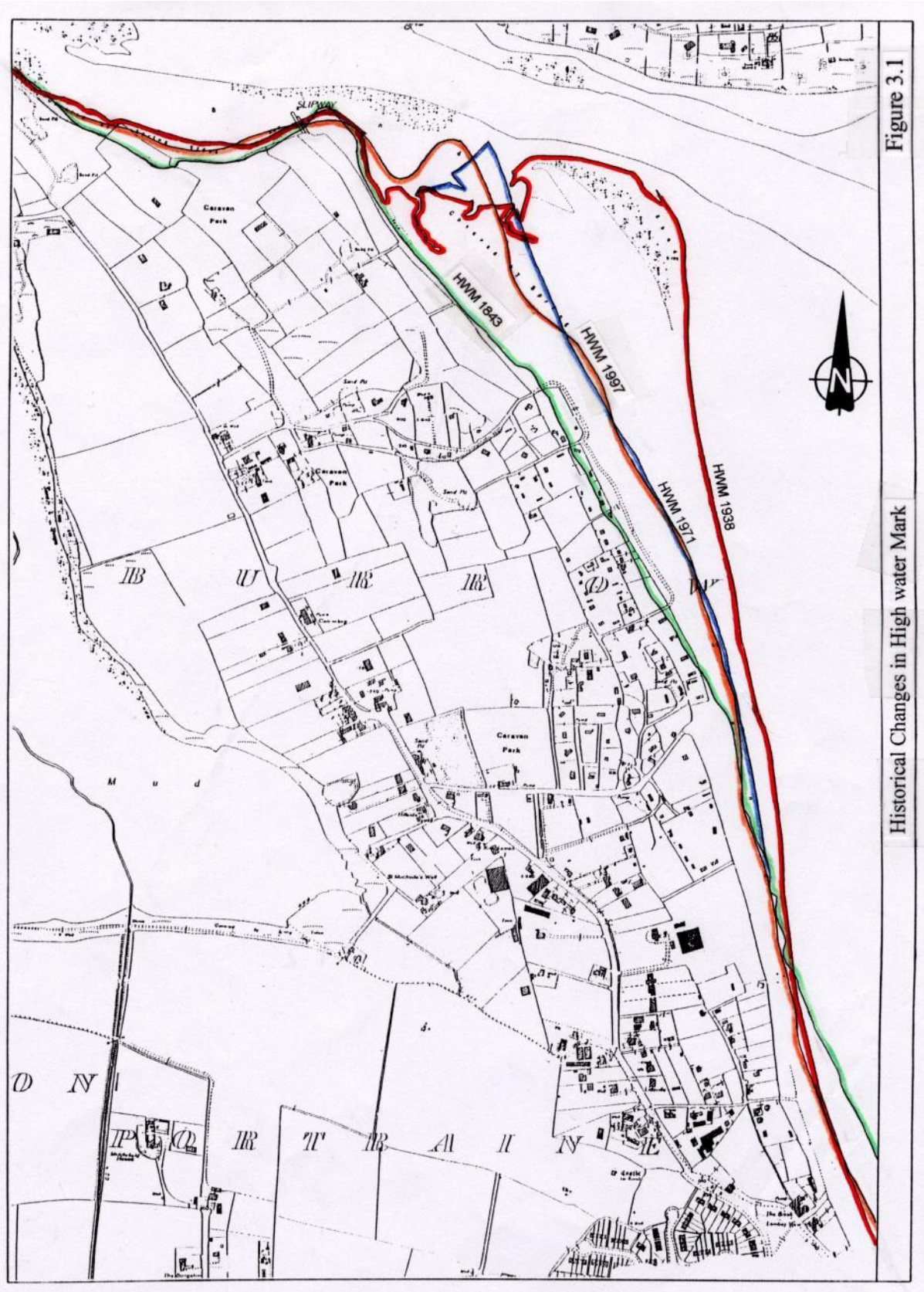

Figure 4.1.1: Historical changes in high water mark

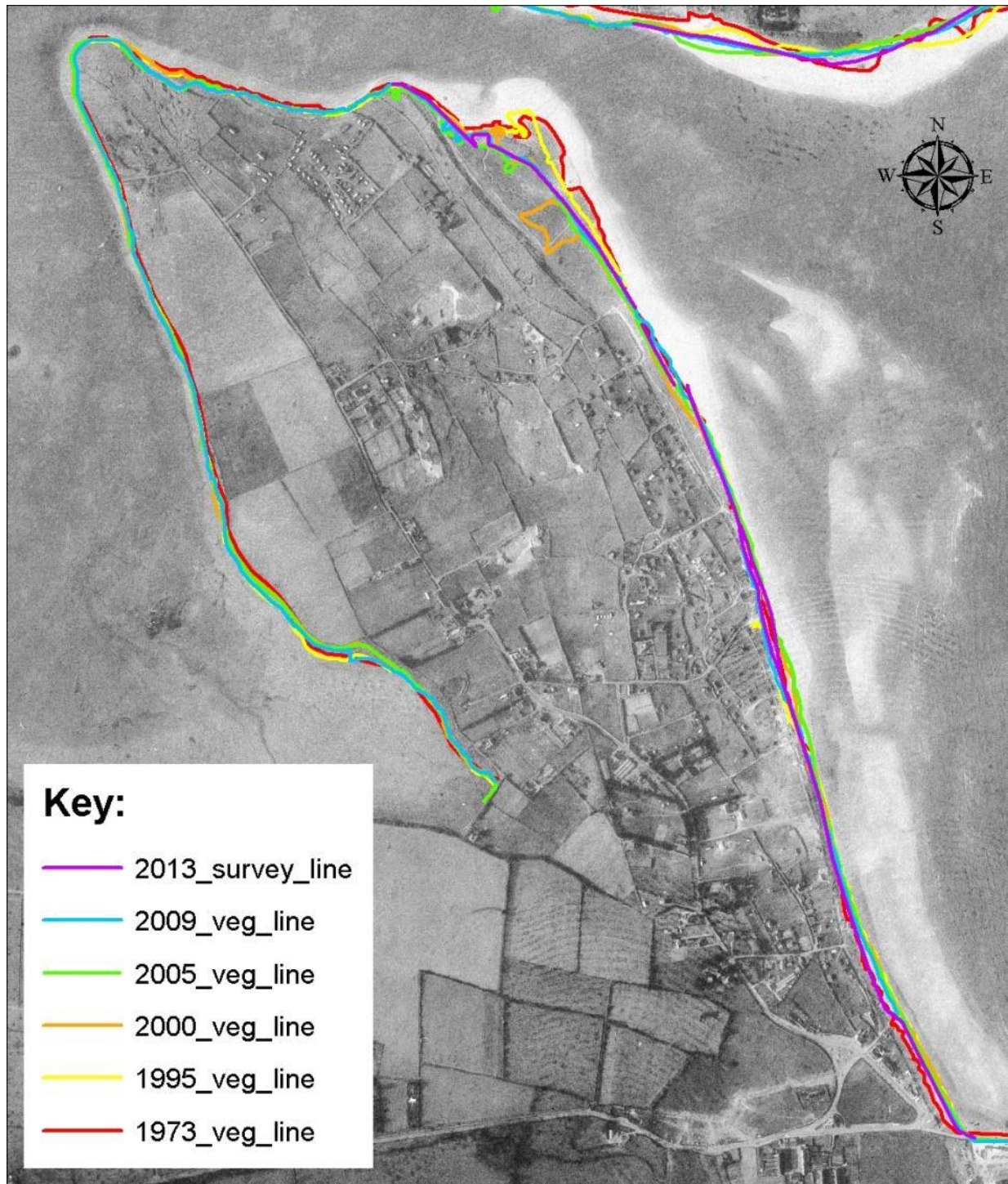

Figure 4.1.2: Portrane - vegetation lines from OS aerial photos superimposed on 1973 photograph

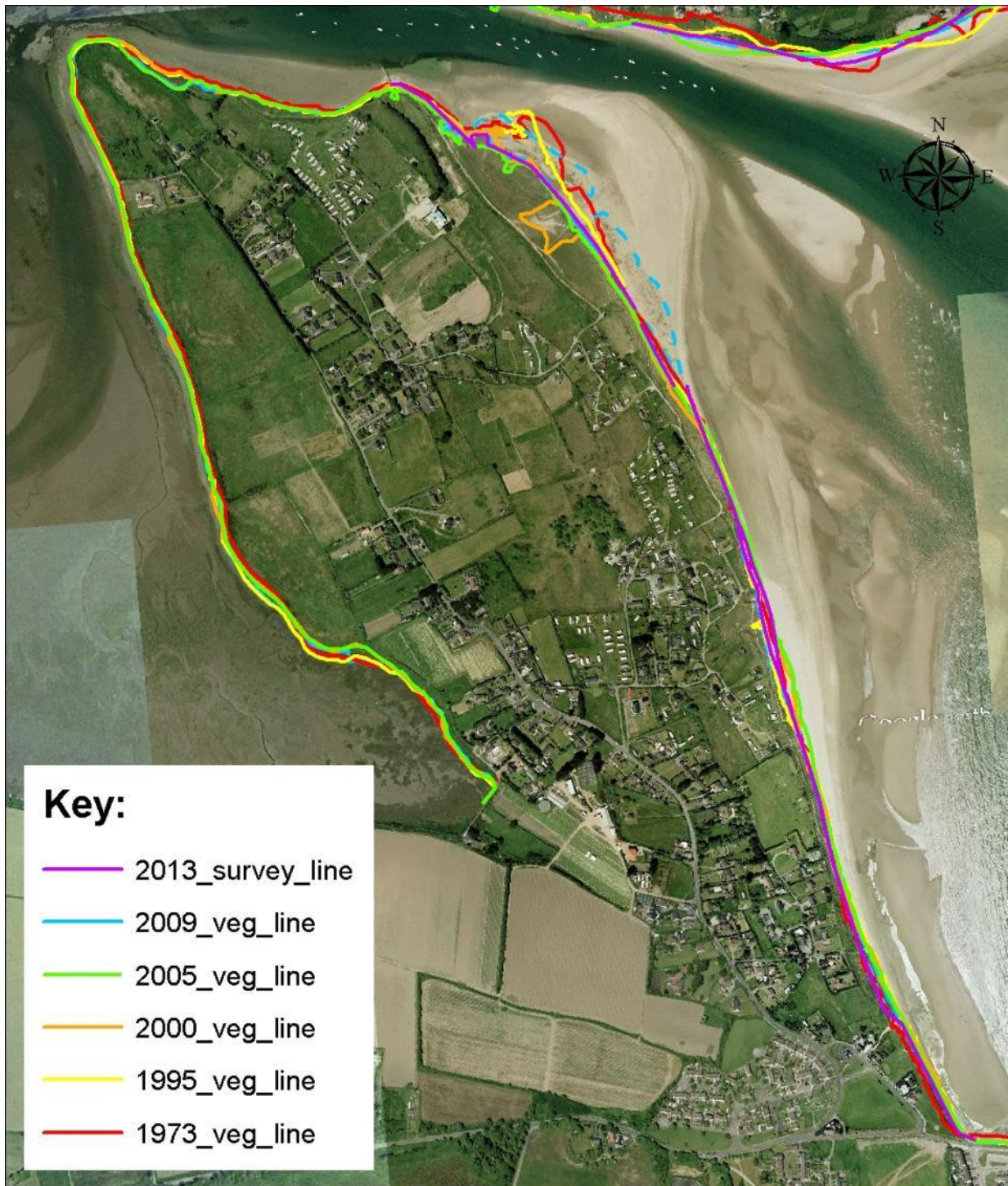

Figure 4.1.3: Portrane - vegetation lines from OS aerial photos superimposed on 2009 photograph

4.2 PORTRANE

When examining the aerial photographs of the Burrow, Portrane, it can be seen that there appears to be three distinct “zones” on its eastern shore where significant movement of the dune line has occurred through the past 40 years. These “zones” are broadly outlined in Figure 4.2.1 below.

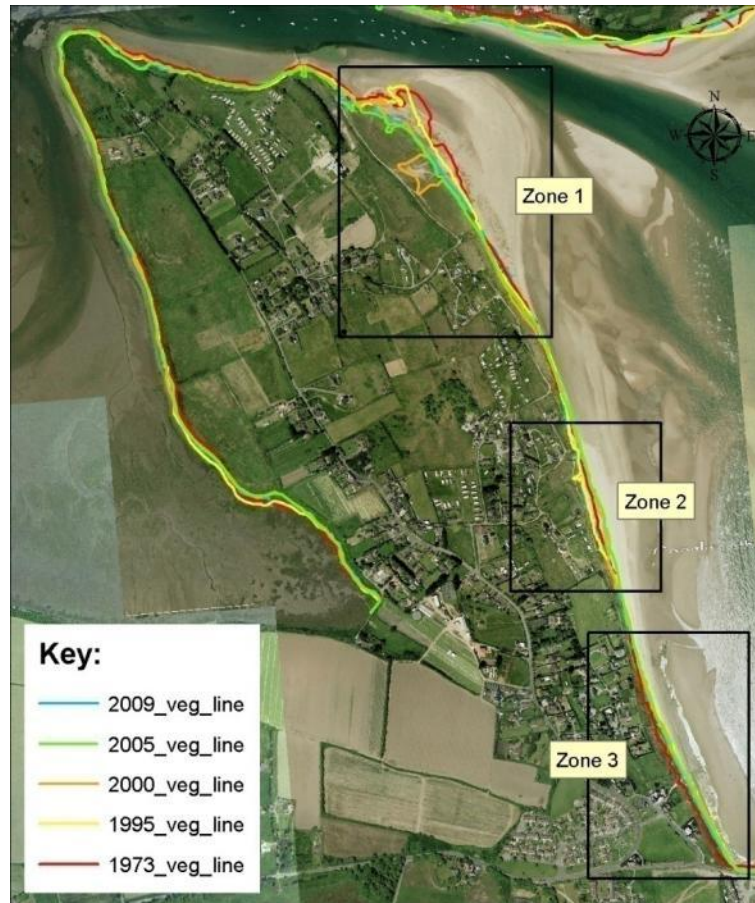

Figure 4.2.1: “Zones” of erosion/accretion on Portrane beach

4.2.1 Portrane beach northern section - “Zone 1”

It can be seen in Figure 4.1.2 and Figure 4.1.3 and the photographs in *Appendix A* that the greatest changes have occurred at the northernmost end of the beach (Zone 1).

Broadly speaking, this zone has been subject to net erosion in the years between 1973 and 2013. In the 1973 photograph, the vegetated area, which in this area is largely salt marsh habitat, extended approximately 80 metres further east than it does in 2013. In the 1982 photograph, a fairly substantial sand spit has formed to the east of the sand dunes and salt marsh, with a tidal lagoon separating it from the Burrow. However, by 1995 the spit has gone, and the vegetation line of the salt marsh area is some 30 metres west of the 1973 extent.

Further erosion took place between 1995 and 2000 and a large area, bare of vegetation, is evident in the 2000 photograph, this area is described in the salt marsh monitoring project (McCorry & Ryle, 2009) as a blow out.

In the southern part of the zone, it can also be seen in the photographs in *Appendix A* that the dunes accreted eastward by a distance of up to 20 metres between 1973 and 1982, but subsequently significant amounts of erosion occurred between 1982-2000, with the dune line moving west by 35 metres from the 1982 .

Since the 2000 photograph, in this area the vegetation line has remained more or less stable, with only a few metres of movement of the vegetation line occurring since then. The “blow out” area seen in the 2000 photograph is partially restored by the 2005 photograph and is almost fully re-vegetated by the 2009 photograph, though there is still a small area bare of vegetation surrounding what appears to be a pedestrian access path. The 2009 photograph and 2013 survey also show an area east of the salt marsh, measuring around 230m by 40m that is above the normal high water mark and which is gradually increasing in vegetation cover. If this area were to continue accretion and colonisation, it would bring the vegetation line close to where it was in 1973.

The 2009 photograph and 2013 survey also show a sand bank is once again developing east of the salt marsh area, therefore it would appear that there has been net accretion in this part of the beach since 2005.

4.2.2 Portrane beach central section - “Zone 2”

In the central section of the beach, it can be seen that the vegetation line moved east (indicating substantial dune accretion) by up to 25 metres between 1973 and 1982. Following this, there appears to have been significant erosion in the period 1982-1995, with the vegetation line moving westwards again by as much as 30 metres. In the period 1995-2000, there was another episode of accretion with the vegetation line moving east again by around 10 metres.

Between 2000 and 2005 the vegetation line was relatively stable, with little change in its position evident in the photographs. However, the 2000 photograph shows much more sparse coverage of the vegetation, with a greater amount of bare areas and erosion of paths/pedestrian access areas. The cover appears more dense in 2005 and the paths are much more defined.

The 2009 photograph shows a further period of erosion occurred between 2005 and 2009, with retreat of around 15 metres, returning the dunes to approximately the same position as in 1995.

4.2.3 Portrane beach southern section - “Zone 3”

The southern section of the beach is currently the area of greatest concern for erosion and there are several permanent dwellings at this part of the coast that are less than 50 metres behind the beach.

When the aerial photographs are reviewed, the present day (2013) surveyed vegetation line is very similar to that in the 1973 photograph, suggesting that in real terms, the shoreline has to date not eroded any further west than has been previously experienced).

It can be seen that there was a period of significant accretion in this zone following the 1973 photograph, with the vegetation line moving up to 20 metres east by 1995.

Following this, the vegetation line remained relatively static in the 2000 and 2005 photographs. It can be seen in the 2009 photograph that some erosion (a westward movement of the vegetation line, in the order of 3-5 metres) occurred in the period 2005-2009.

More substantial rates of erosion are seen to have occurred in the period between the 2009 aerial photograph and the present day and it would appear that up to 15 metres of the dune line has been eroded in this area over the past 4 years, particularly in the area just north of the main access to the bathing area, where sandbags have now been placed.

4.3 RUSH

Aerial photographs of Rush dating from 1973 to 2009 are shown in Figure 4.3.1 and Figure 4.3.2 respectively. Further photographs from the years 1995, 2000 and 2005 are included in *Appendix A*.



Figure 4.3.1: Rush - vegetation lines from OS aerial photos superimposed on 1973 photograph



Figure 4.3.2: Rush - vegetation lines from OS aerial photos superimposed on 2009 photograph

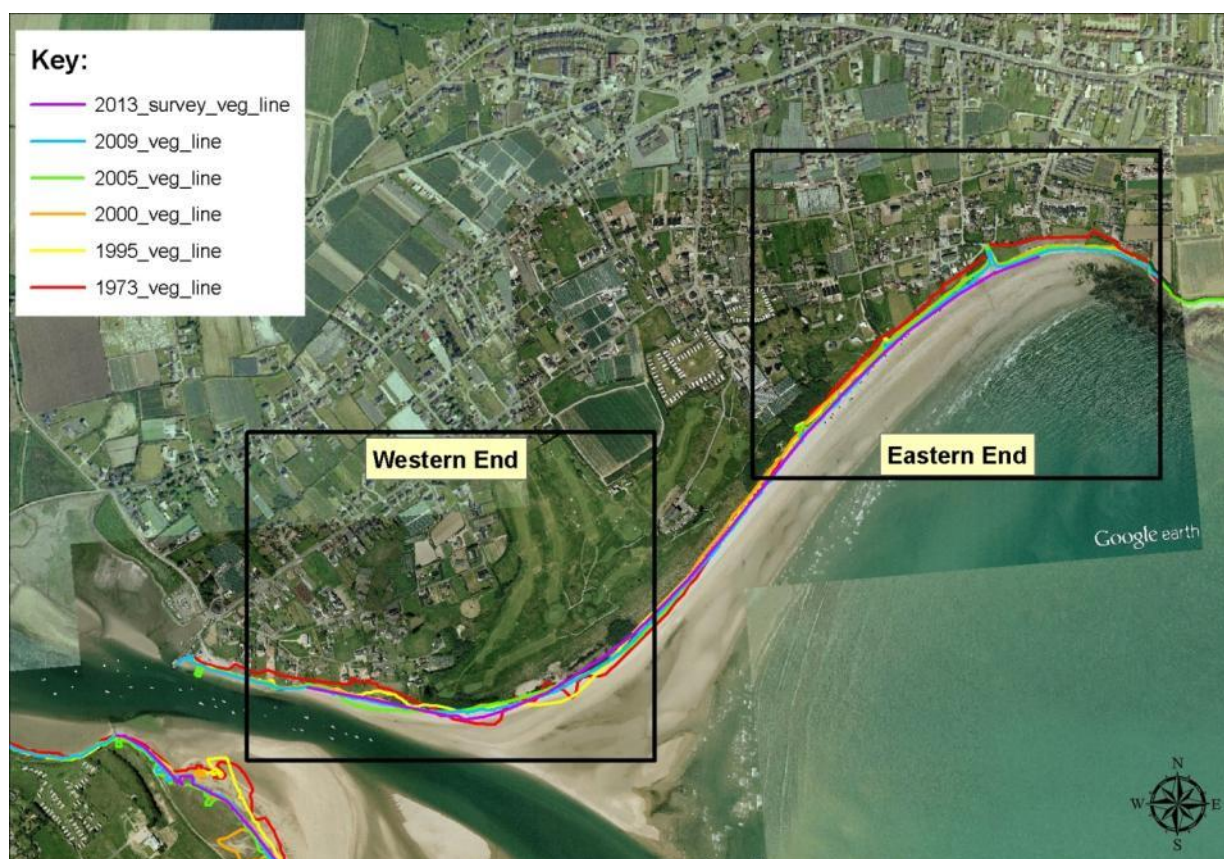

Figure 4.3.3: “Zones” of erosion/accretion on Rush beach

4.3.1 Rush Beach Western End

The western end of Rush beach has seen quite marked changes in the vegetation line over the early part of the aerial photographs timescale. It can be seen in the 1973 photograph that there is much more horticulture and less residential development at the western end of the beach than at present. In the area closest to the boat club, the vegetation line is much further set back than in the 1995 onwards photographs, by up to 28 metres in the area of the boat club. However, the subsequent photos show relatively little change in the vegetation line after 1995 in this area.

Immediately to the west of the golf club perimeter, there is another area that saw significant accretion between 1973 and 2005, with the vegetation line moving some 50 metres south. However, it can be seen that this area then suffered some erosion between 2005 and 2009, losing around 15 metres and returning to an alignment approximately similar to that of 2000 by 2013.

In the area fronting the golf course itself, it can be seen that the vegetation line was substantially further south in the 1973 photograph than in subsequent photographs with quite substantial variation in 1995. Subsequent to 1995, the area has remained relatively stable, although some erosion (around 10 metres) has occurred in places between 2009 and 2013.

4.3.2 Rush Beach Eastern End

The area behind the eastern end of Rush beach has also seen considerable development in the years between 1973 and the present, with housing developments replacing caravan parks and cultivation areas.

It can be seen that throughout this area, gradual accretion of the beach has occurred, with the vegetation line moving steadily south. There appears to have been rapid accretion and vegetation between the 1973 and the 1995 photographs.

The accretion is more pronounced at the eastern end of the beach, in the bathing area, where the vegetation line has moved more than 50 metres southwards in the period 1973-2013.

5 WALK OVER SURVEY MAY 2013

A walk over survey and condition survey of the coastline at both Portrane and Rush was carried out on 24 May 2013.

5.1 PORTRANE



Figure 5.1.1: Accreting area at northern end of Portrane (view north)



Figure 5.1.2: view south from northern end of Portrane beach (accreting area)



Figure 5.1.3: Dune growth area, mid beach (looking north)



Figure 5.1.4: Eroding area, southern end of beach (looking north)



Figure 5.1.5: Erosion damage, southern end of beach (looking north)



Figure 5.1.6: Wooden boardwalk with erosion damage, south end of beach (looking north)



Figure 5.1.7: Wooden boardwalk view south showing erosion protection sandbags



Figure 5.1.8: Sandbags at southern end of the beach



Figure 5.1.9: Erosion around southern bathing beach access area



Figure 5.1.10: Southernmost end of Portrane beach, looking north

5.2 RUSH



Figure 5.2.1: Rush boat club erosion and undermining



Figure 5.2.2: Rush golf club area erosion



Figure 5.2.3: Accretion at eastern end Rush Golf Club



Figure 5.2.4: Rush bathing area, view east



Figure 5.2.5: Rush eastern end bathing area – stable/accreting vegetation



Figure 5.2.6: Rush eastern end bathing area, rock armour

6 BEACH TOPOGRAPHIC SURVEY AND SEDIMENT ANALYSIS

Sediment samples were recovered from four stations at each of the three transects across the beaches at both Portrane and Rush (see Figure 5.2.1) to aid in the understanding of the littoral sediment transport at the beaches. The 24 samples were then sent to the laboratory at Queen's University, Belfast, for particulate size analysis. The full results of the analysis are presented in *Appendix B* and grading curves for the samples are shown in Figure 5.2.2 to Figure 5.2.7.

The analysis shows that the majority of the sediment on the beaches at Portrane and Rush is comprised of fine sand. The beaches at Rush had a more significant fraction of very fine sand than those at Portrane, particularly the samples taken closer to the low water mark.



Figure 5.2.1: Location of Sediment Sampling Stations

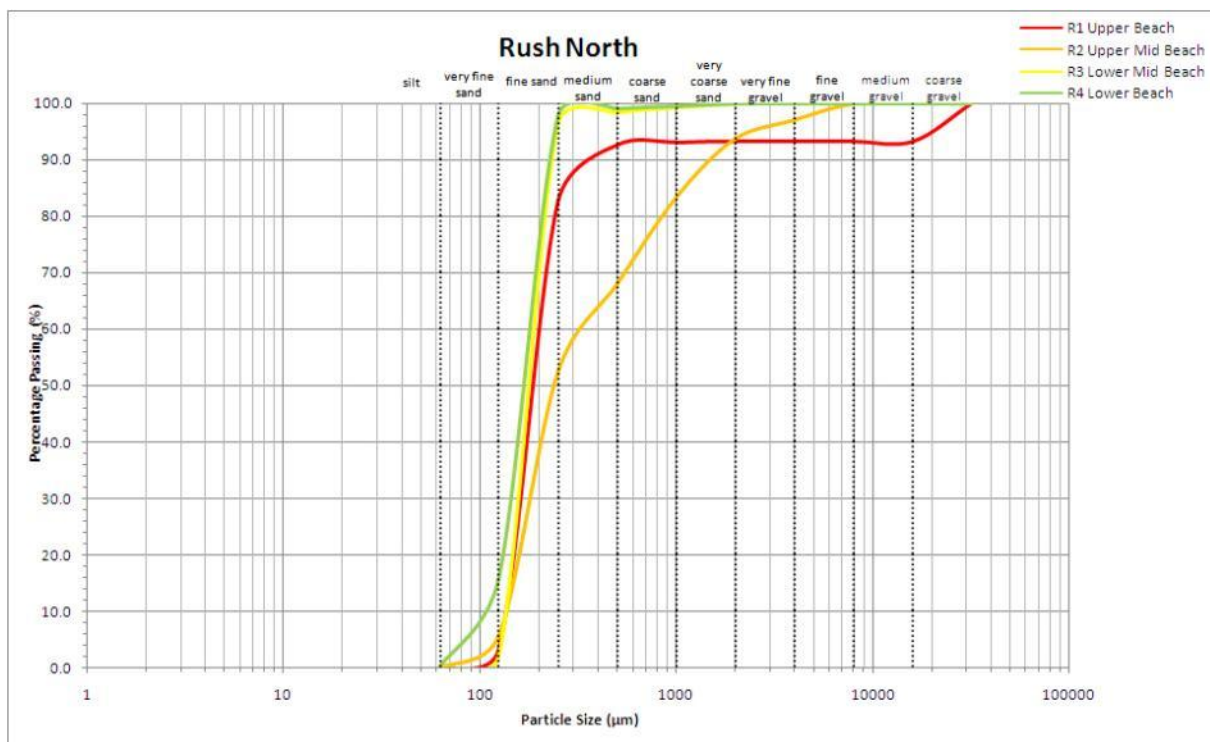

Figure 5.2.2: Sediment Grading Curves, samples from Rush North

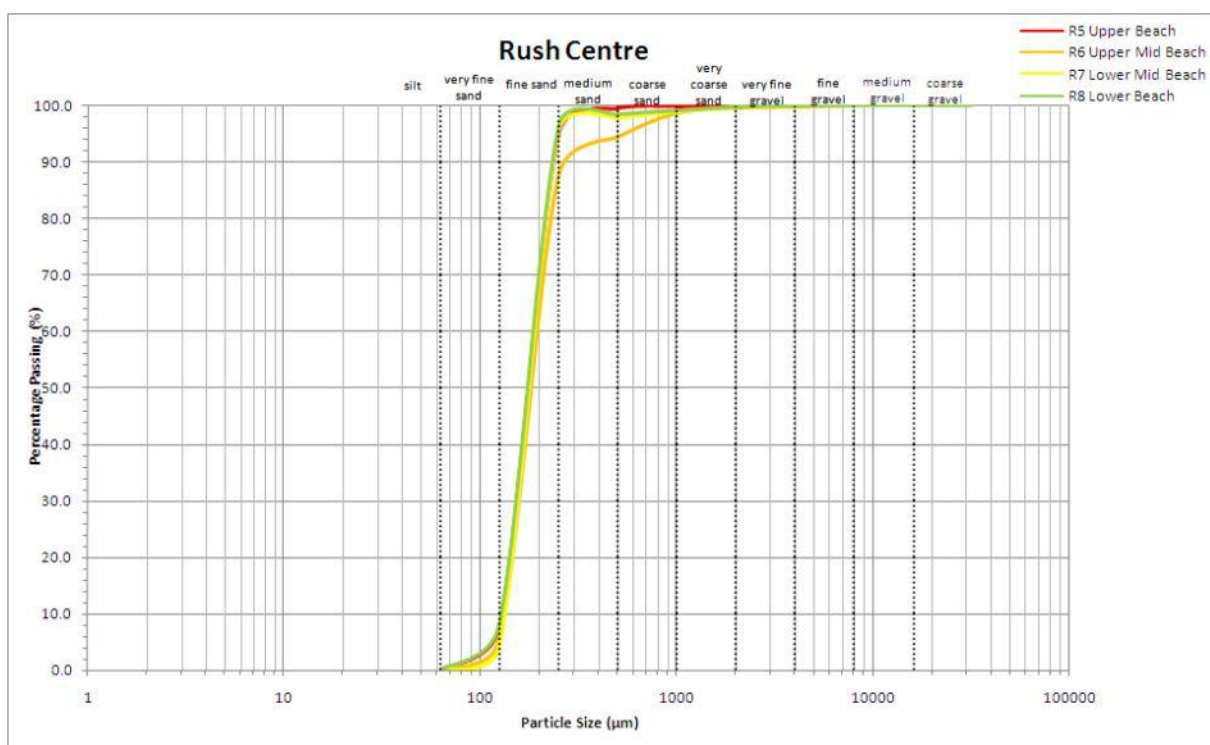

Figure 5.2.3: Sediment Grading Curves, samples from Rush Centre

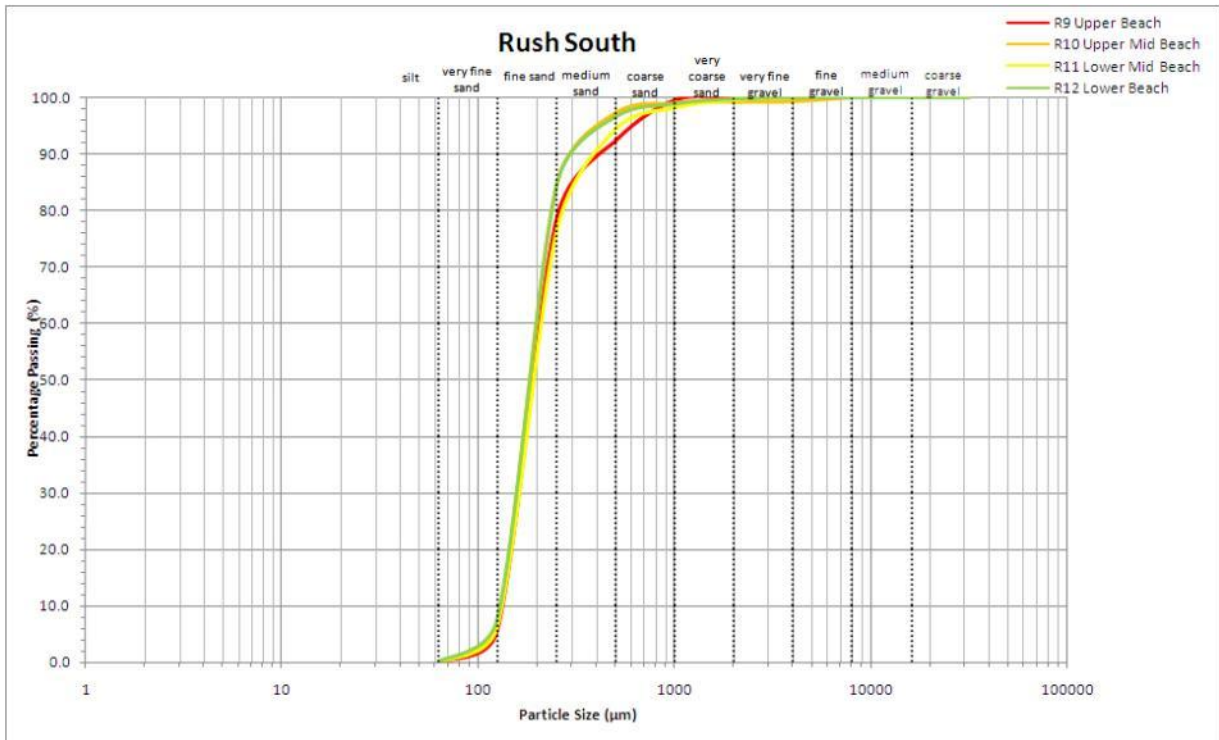

Figure 5.2.4: Sediment Grading Curves, samples from Rush South

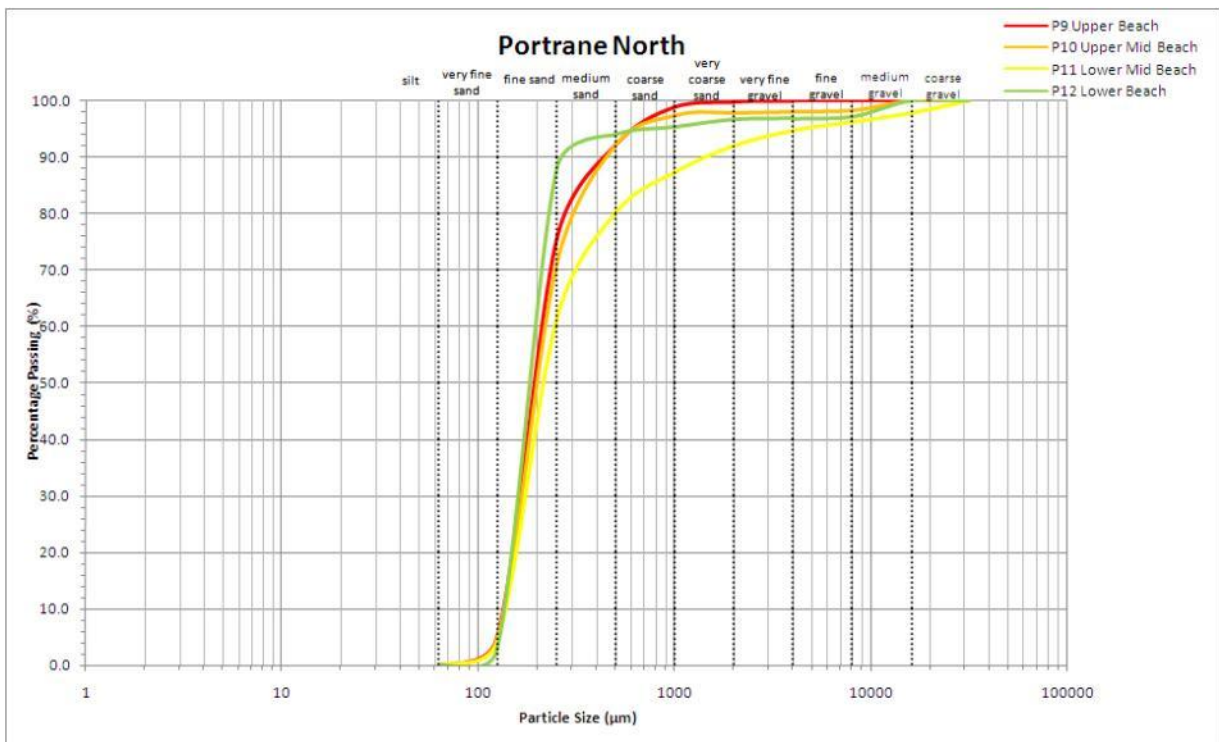

Figure 5.2.5: Sediment Grading Curves, samples from Portrane North

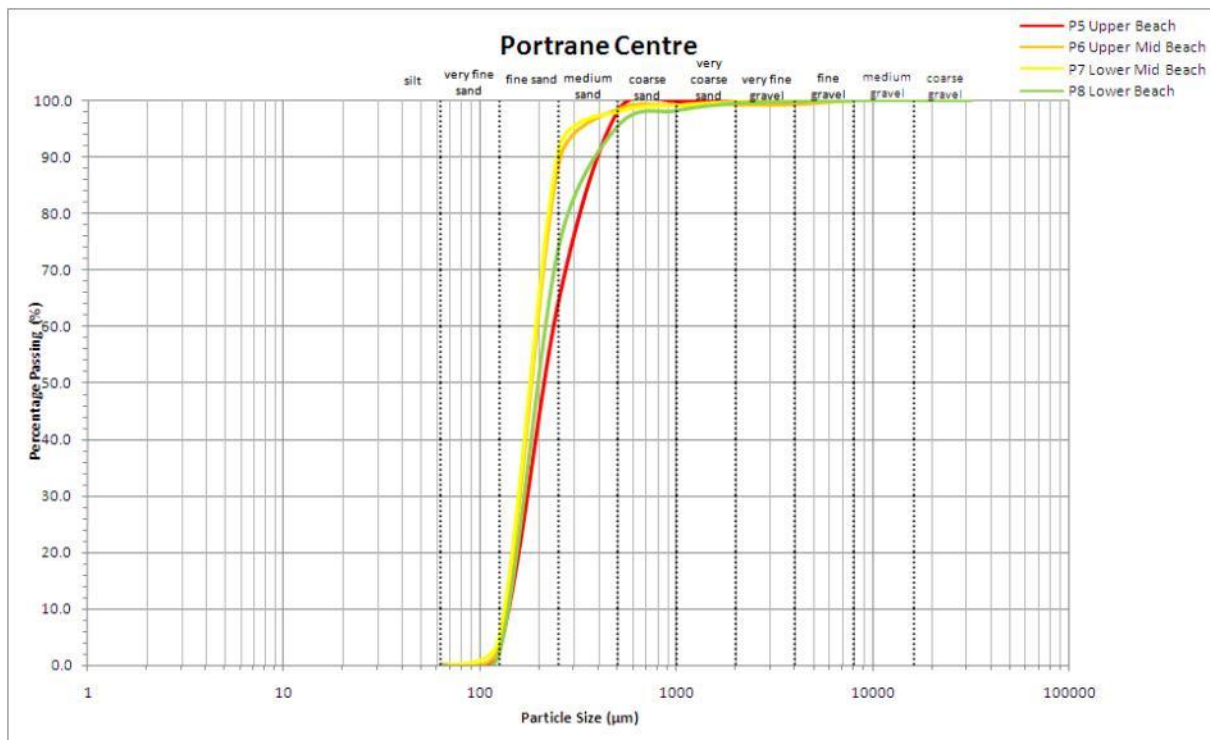

Figure 5.2.6: Sediment Grading Curves, samples from Portrane Centre

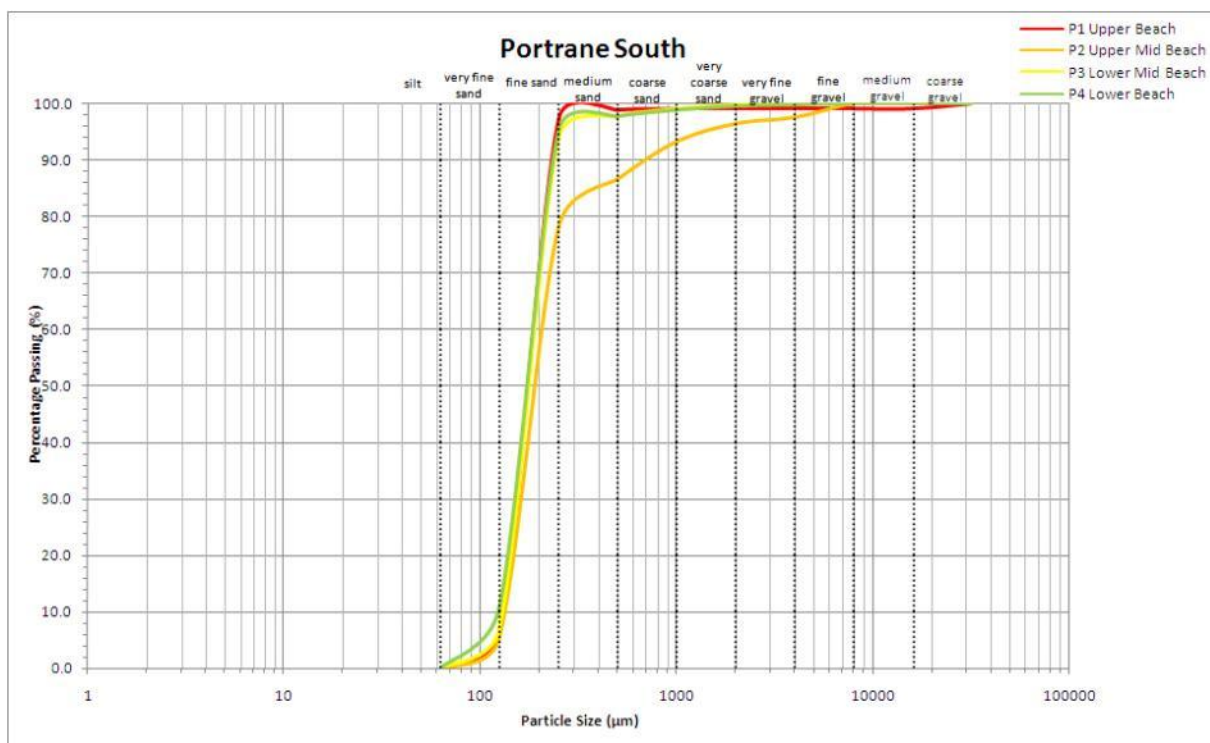

Figure 5.2.7: Sediment Grading Curves, samples from Portrane South

7 HYDROGRAPHIC SURVEY

A single beam hydrographic survey was conducted using a 6m cabin boat and 3m survey dinghy to obtain recent high resolution bathymetric data of the Rogerstown estuary inlet and of the surrounding Portrane and Rush area (see Figure 5.2.1). This data was used to update existing bathymetric data of the area, held by RPS.

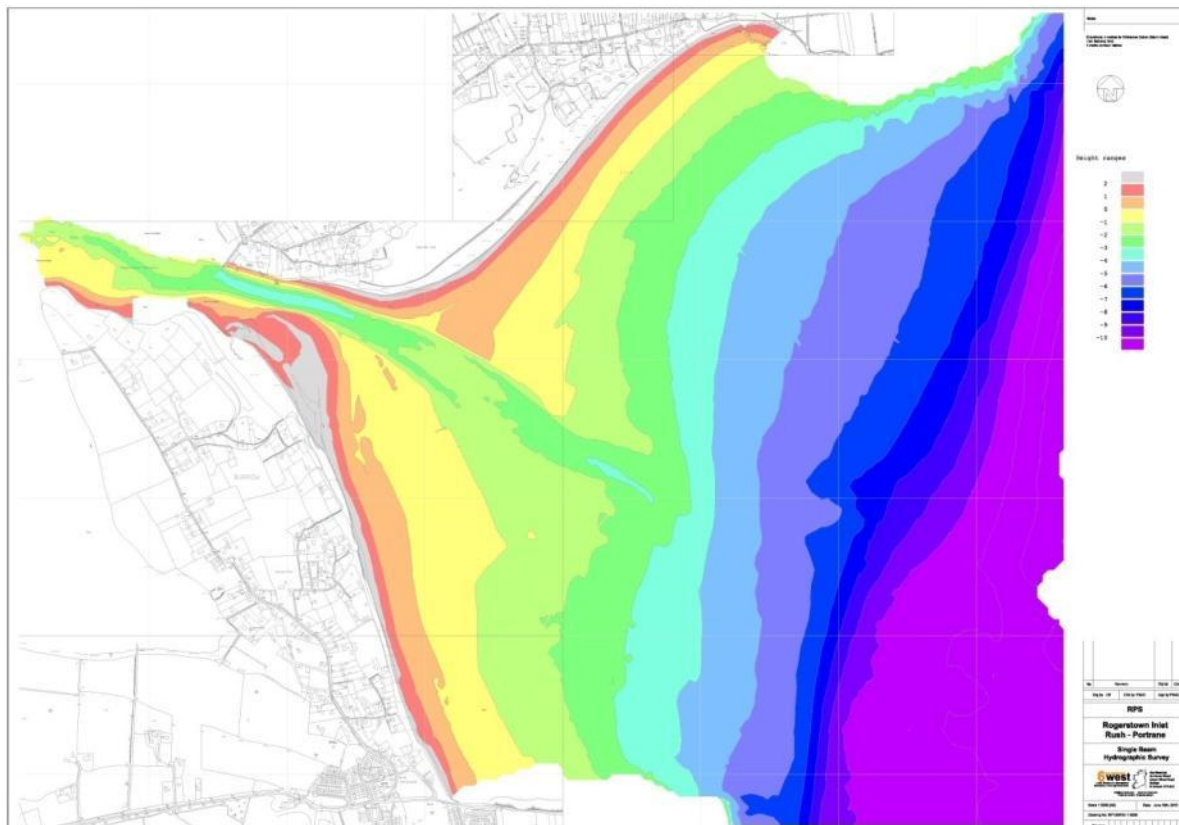

Figure 5.2.1: Figure 7.1: Area covered by the 2013 Hydrographic Survey

8 COASTAL PROCESSES AND COASTLINE EVOLUTION

8.1 BATYMETRY AND COASTAL PROCESS MODEL

The analysis required the bathymetry of Rogerstown Estuary and the surrounding coast of Portrane and Rush to be included in the model. RPS utilised their Irish Sea tidal and Storm Surge model that uses flexible mesh technology with the mesh size (model resolution) varying from circa 24km along the offshore Atlantic boundary to circa 200m around the Irish coastline to form the boundary conditions for two finer grid models of the study area and the surrounding sea area. The extent and bathymetry for the Irish Sea tidal and Storm Surge model is presented in Figure 8.1.1 below.

Data from the base model was used to provide the boundary conditions for a 50m grid tidal model of an area from Skerries to Portmarnock. A tidal sub model that was constructed using flexible mesh technology with the mesh size varying from 50m to 15m was then adapted to include the new bathymetric data collected by the hydrographic and topographic surveys described in section 6.0 and 7.0, and further developed to provide more detailed flow information for the sediment transport model. The boundaries and meshing of the outer and inner tidal sub models of the study area are presented in Figure 8.1.2 to Figure 8.1.4 respectively.

A previously undertaken hydrodynamic survey of the Rogerstown estuary by RPS for an outfall study for the Portrane-Donabate WWTW from 2003-2010 recorded the mean flow values of the Ballyboghil and Corduff rivers. These mean flow values were used as freshwater inputs in the tidal flow model. The hydrodynamic model was then calibrated against current meter data that was acquired by RPS for previous studies to ensure that the local tidal regime was accurately represented.

In order to accurately model the water exchange between the study area and the Irish Sea, it was necessary to ensure that the boundary conditions of the model were sufficiently far offshore to ensure the area of interest was not influenced.

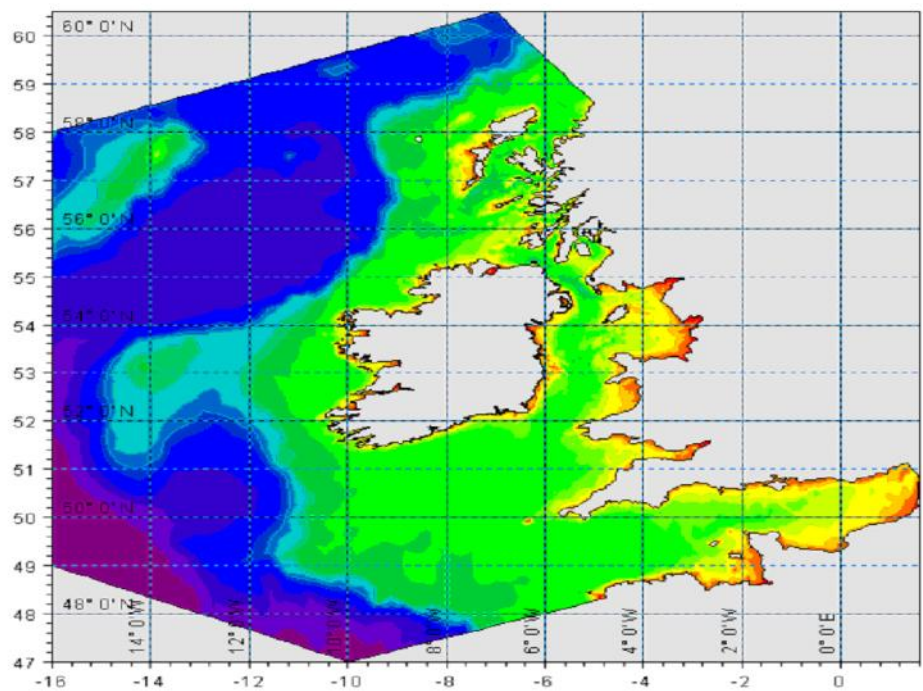

Figure 8.1.1: Extent and bathymetry of Irish Sea tidal and Storm Surge model.

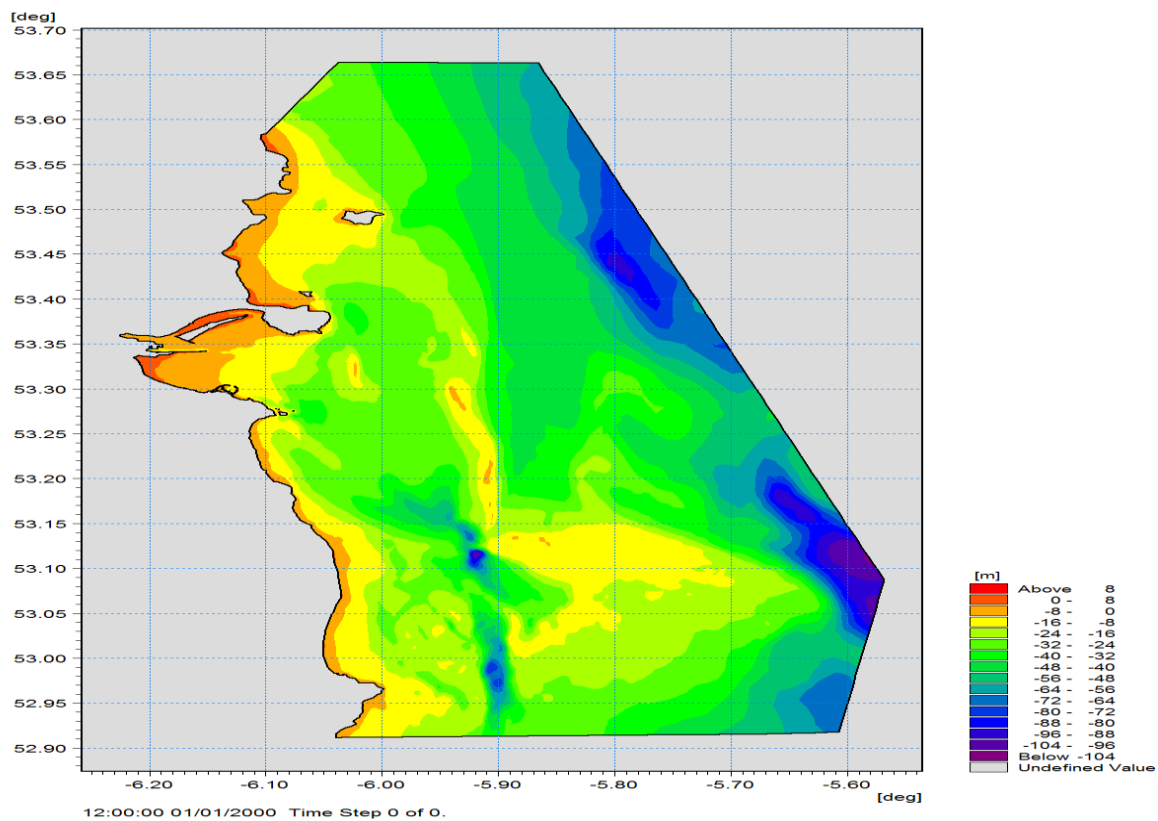

Figure 8.1.2: Extent and bathymetry of the outer Portrane model.

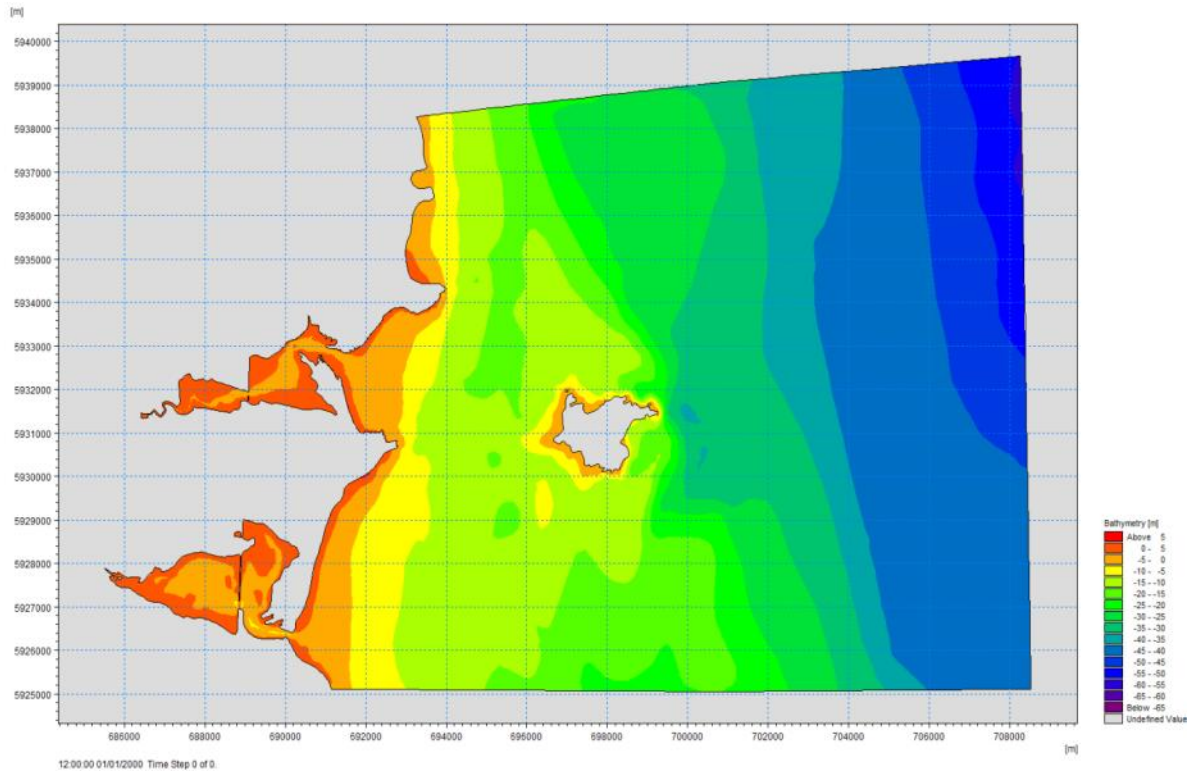

Figure 8.1.3: Extent and bathymetry of the inner Portrane model.

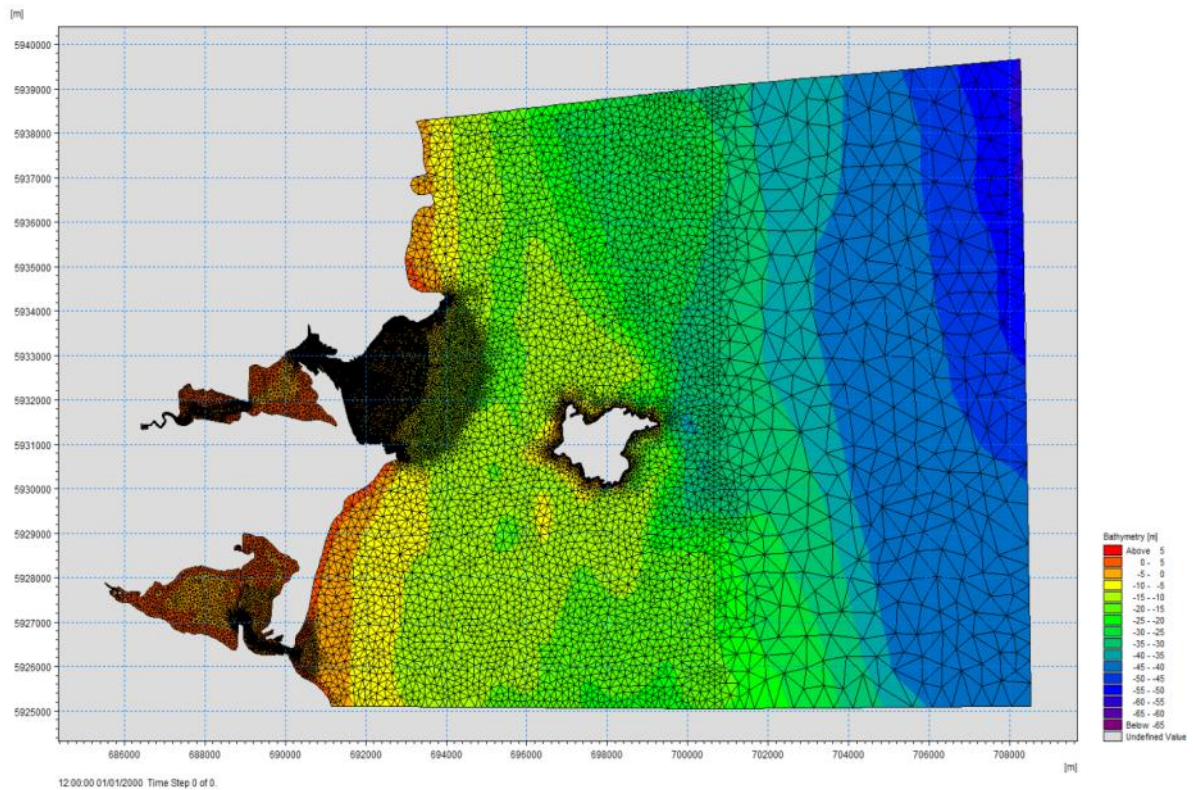

Figure 8.1.4: Computational Mesh of the inner Portrane model

8.2 TIDAL FLOWS AND LEVELS

8.2.1 Tidal flows

The tidal currents around the study area are complex due to the interaction of Rogerstown Estuary and the Irish Sea Tides that are themselves influenced by Lambay Island.

The characteristics of the tidal flow of the coastal area and of the Rogerstown inlet were established using a suite of two-dimensional depth integrated hydrodynamic flow models, developed at DHI, Denmark. These models were capable of both conserving mass at flooding and at drying cells, which is essential in areas where extensive portions of the beaches are exposed at low waters, as observed at Portrane and Rush.

The tidal regime predicted by the Mike21 models is presented in the form of typical mid-flood, high, mid-ebb, and low regimes in Figure 8.2.1 to Figure 8.2.4. The length and direction of the vectors displayed on each of the outputs are proportional to the magnitude of the current velocity at each nodal point in the grid.

8.2.2 Tidal levels

The tidal levels for the study area have been derived using the Admiralty tidal tables based on Howth. Tidal levels taken by RPS during a site survey for a previous study of the Rogerstown estuary were used to confirm the tidal level relationship between Howth and the study area. The standard levels for Portrane are calculated as follows:

	Chart Datum	OD Malin
Mean High Water Springs	4.1	1.8
Mean High Water Neaps	3.3	1
Mean High Water Springs	1.3	-1
Mean High Water Neaps	0.7	-1.6

As the wave heights that can approach the shoreline are strongly influenced by water depth, an extreme tidal analysis was undertaken as part of the Irish Coastal Protection Strategy Study. The high water levels at Portrane-Rush for various return periods are as follows:

Return Period N (years)	High Water Level - CD
1	4.87
5	5.10
10	5.20
50	5.43
100	5.52
200	5.62

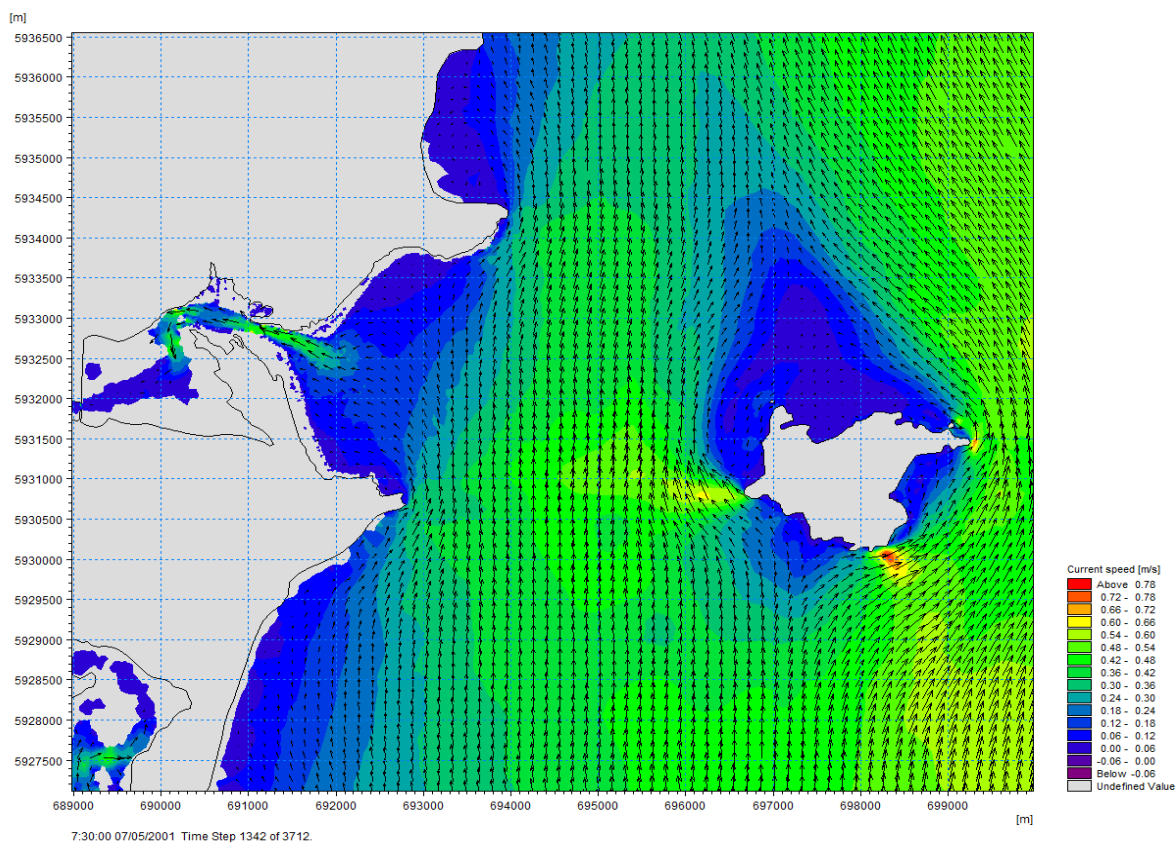

Figure 8.2.1: The tidal regime - Spring Mid Flood.

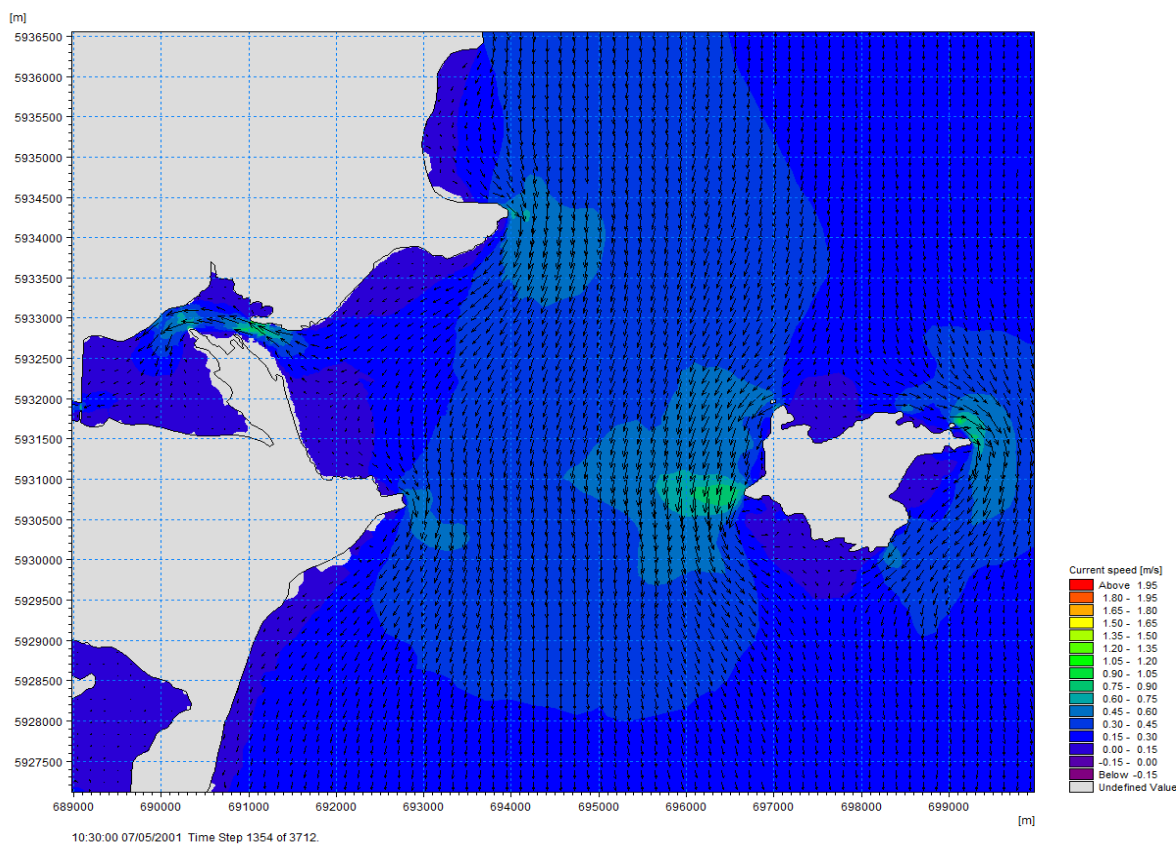

Figure 8.2.2: The tidal regime - Spring high Water.

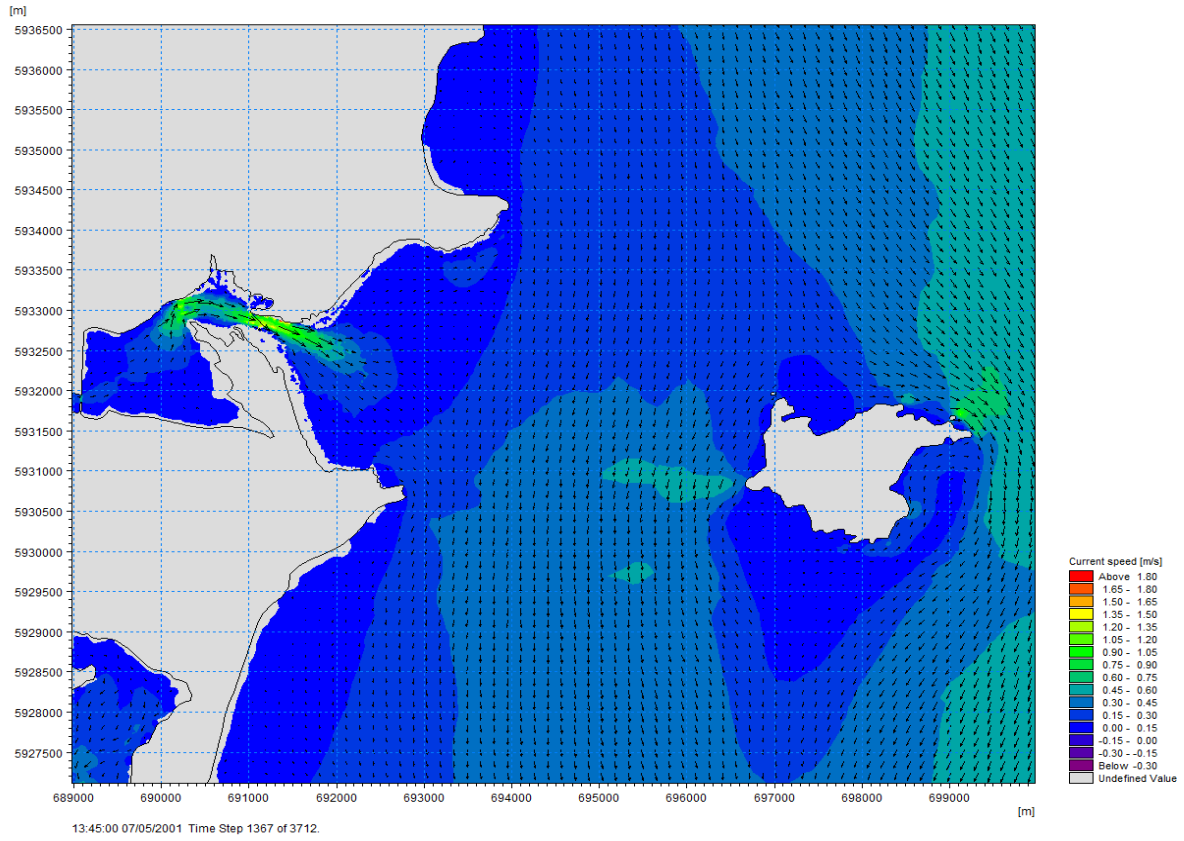

Figure 8.2.3: The tidal regime - Spring Mid Ebb.

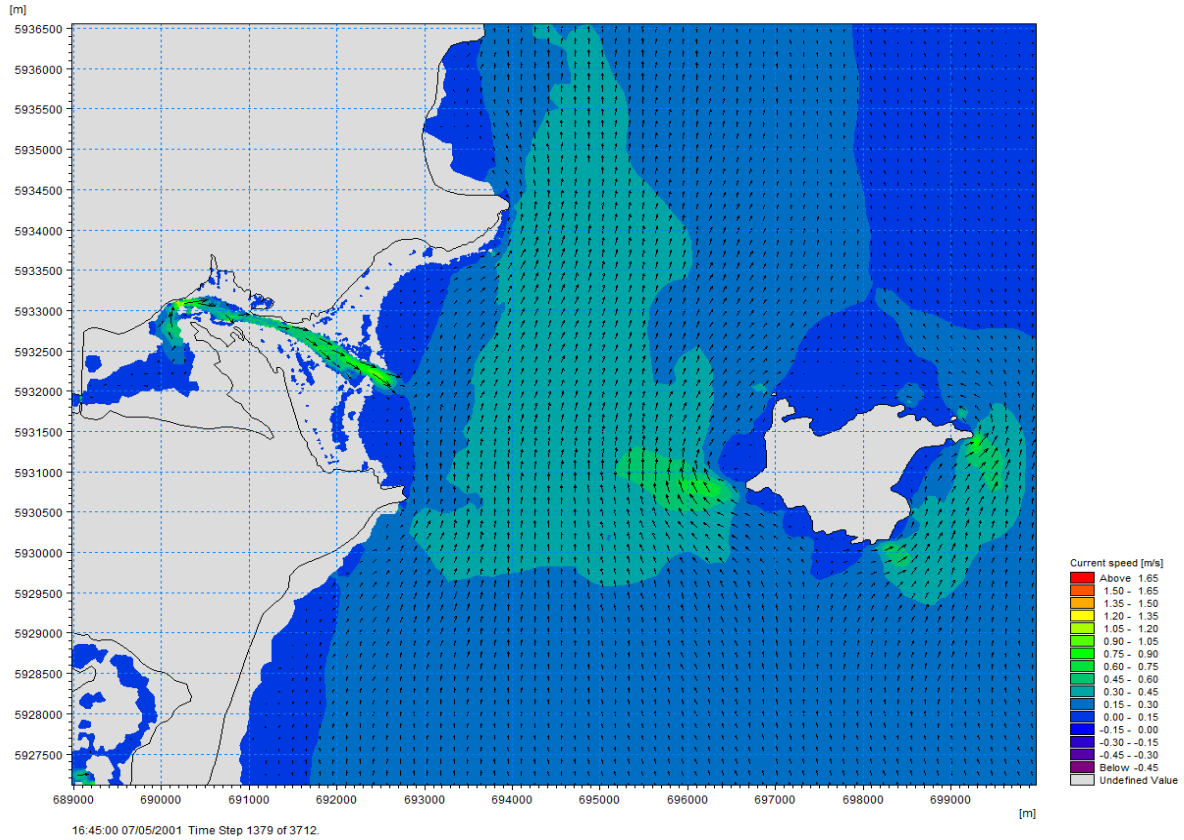

Figure 8.2.4: The tidal regime - Low Water.

8.3 OFFSHORE WAVE AND WIND DATA

The wind and wave data from the UK Met. Office for the years 1990-2004 and the offshore wave data from the European Centre for Medium Range Weather Forecasts (ECMWF) European Waters Wave model for the years 1997-2011 were used as a source to generate 3 hourly annual wave records for an offshore point southwest of Portrane (53.5° N 5.50° W). The 3 hourly data included wind wave and swell wave components in the form of the significant wave height H_{m0} , mean wave period T_m and mean wave directions. Wind speeds and directions were included in the data set.

The wave rose for the 3 hourly significant wave heights for the offshore point is presented below in Figure 8.3.1. The wave rose for the same data set, but displaying only significant wave heights of above 1.5m is also presented in Figure 8.3.2.

The 3 hourly data set generated from UK Met. Office and ECMWF records for 1997-2011 showed that generally the swell wave activity was considerably lower during the summer months, relative to the winter months of December through to January. It is during these winter months that the highest swell waves are observed for each year and are frequently concurrent with periods of high local wave activity.

The wind data from the ECMWF for the years 1997-2011 was analysed for all wind speeds greater than 12m/s. The results of the analysis show consistency throughout the data set, with the majority of the wind coming from the north west, west and south west direction. Although, a change could be observed in the in the 2004-2011 records as strong winds from the north east and south east become more frequent.

This is an important observation as the beaches of Portrane and Rush will be, to an extent, sheltered by the coastline between Howth and Skerries against strong winds and swell activity from the north west, south west and west sectors. Whereas, strong winds and swell activity originating in the north east and south east sectors are not affected by the adjoining shoreline and will therefore increase the amount of incident wave and swell energy that the arrive at the beaches at Portrane and Rush.

The wind rose for the 3 hourly wind velocities for the offshore point is presented below in Figure 8.3.3. Also presented below in Figure 8.3.4 is the wind rose for the same data set, but displaying only wind velocities exceeding 12m/s.

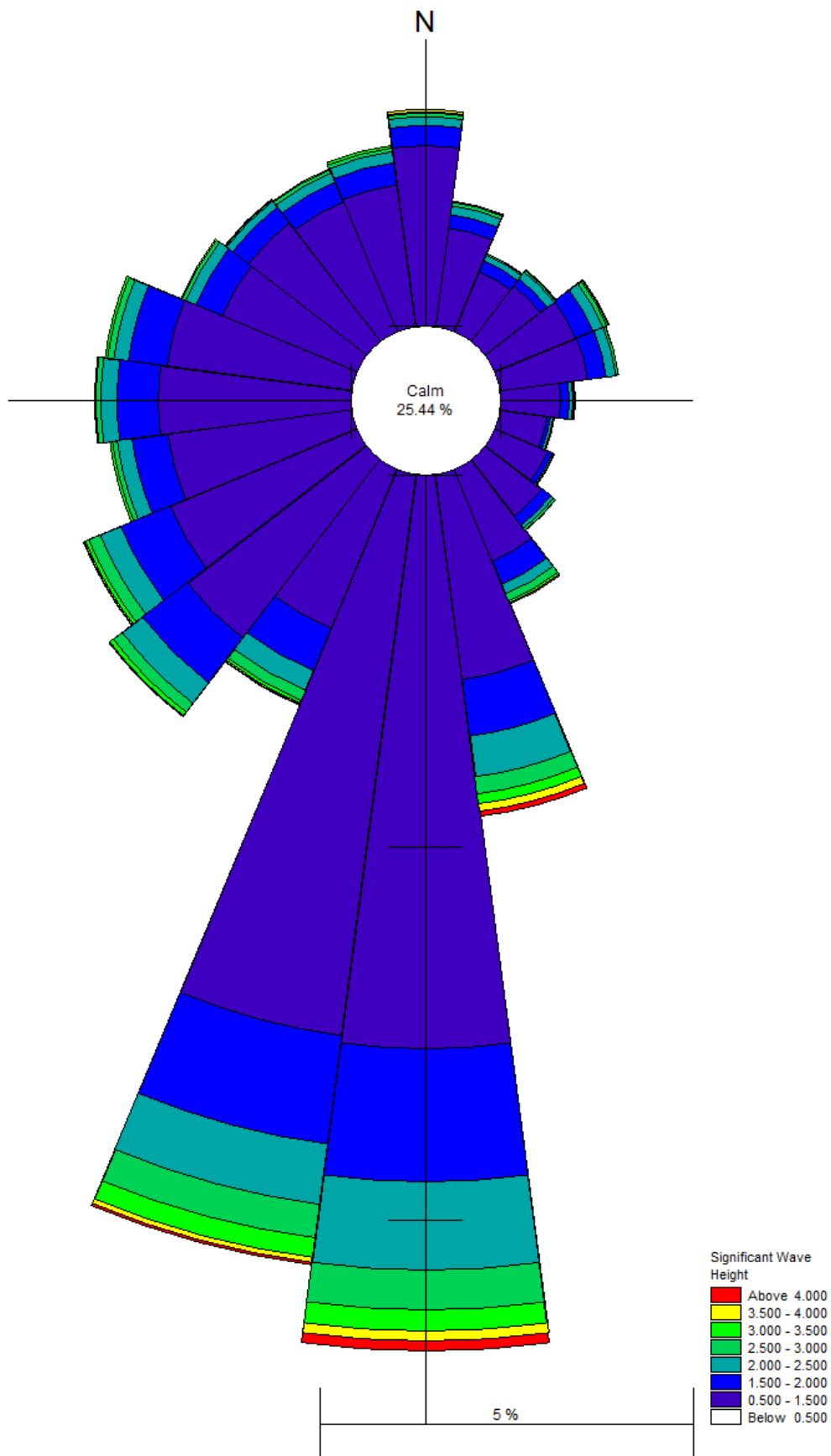

Figure 8.3.1: Wave Rose of the offshore wave climate at the point 53.5° N 5.50° W, 1997-2011.

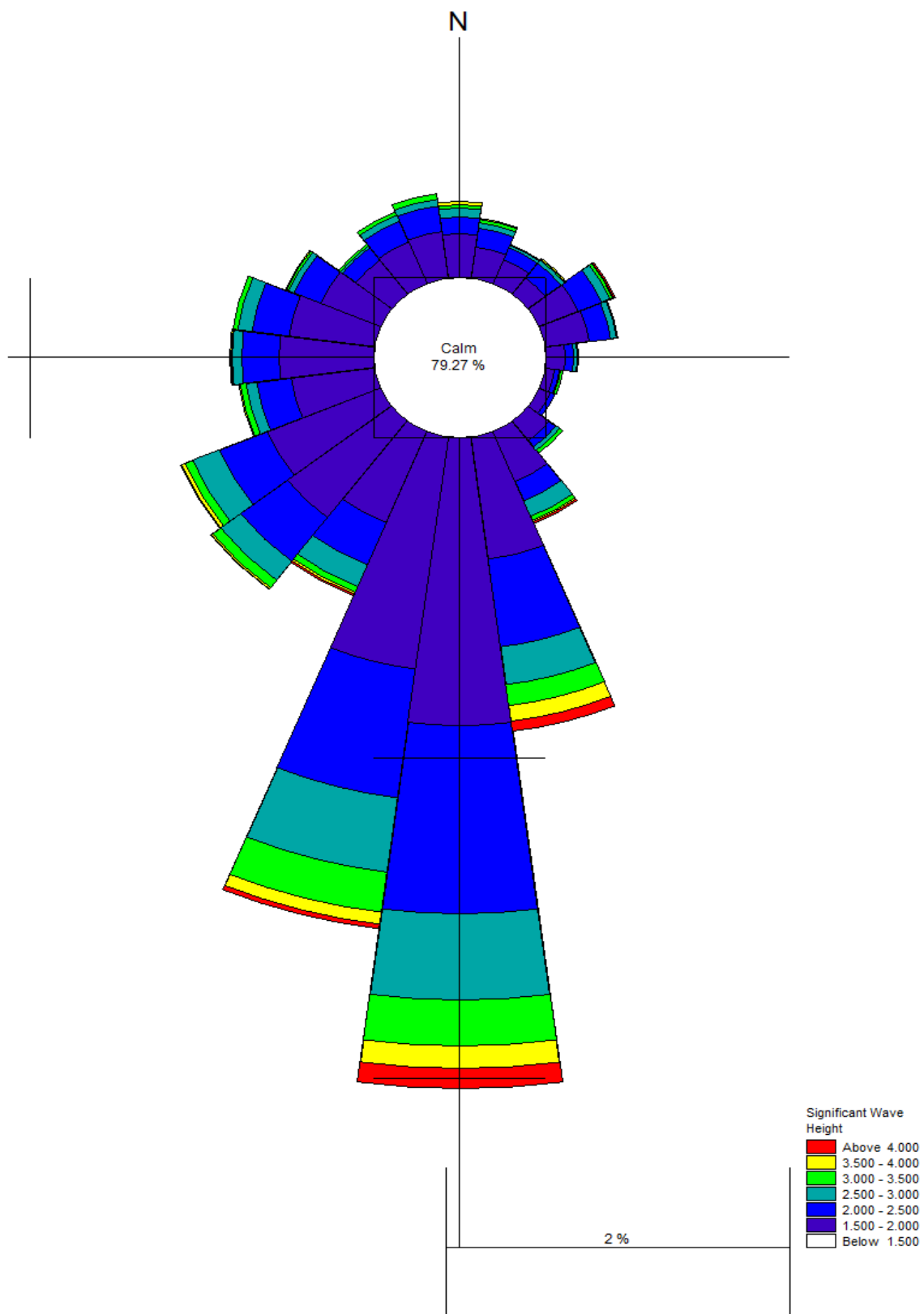

Figure 8.3.2: Wave Rose of Significant Wave Heights above 1.5m for the offshore point 53.5° N 5.50° W, 1997-2011.

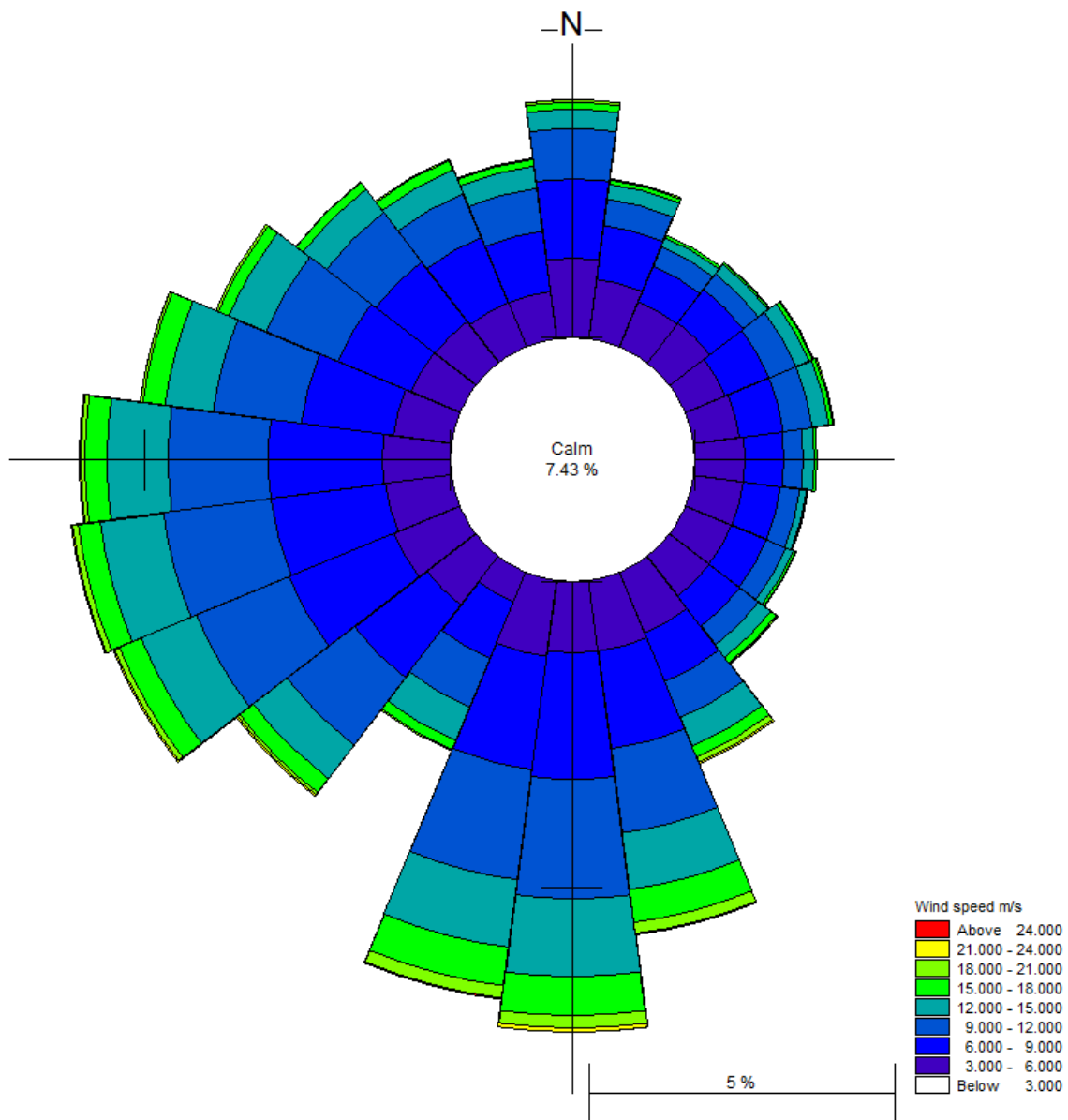

Figure 8.3.3: Wind Rose of the offshore wind climate at the point 53.5° N 5.50° W, 1997-2011.

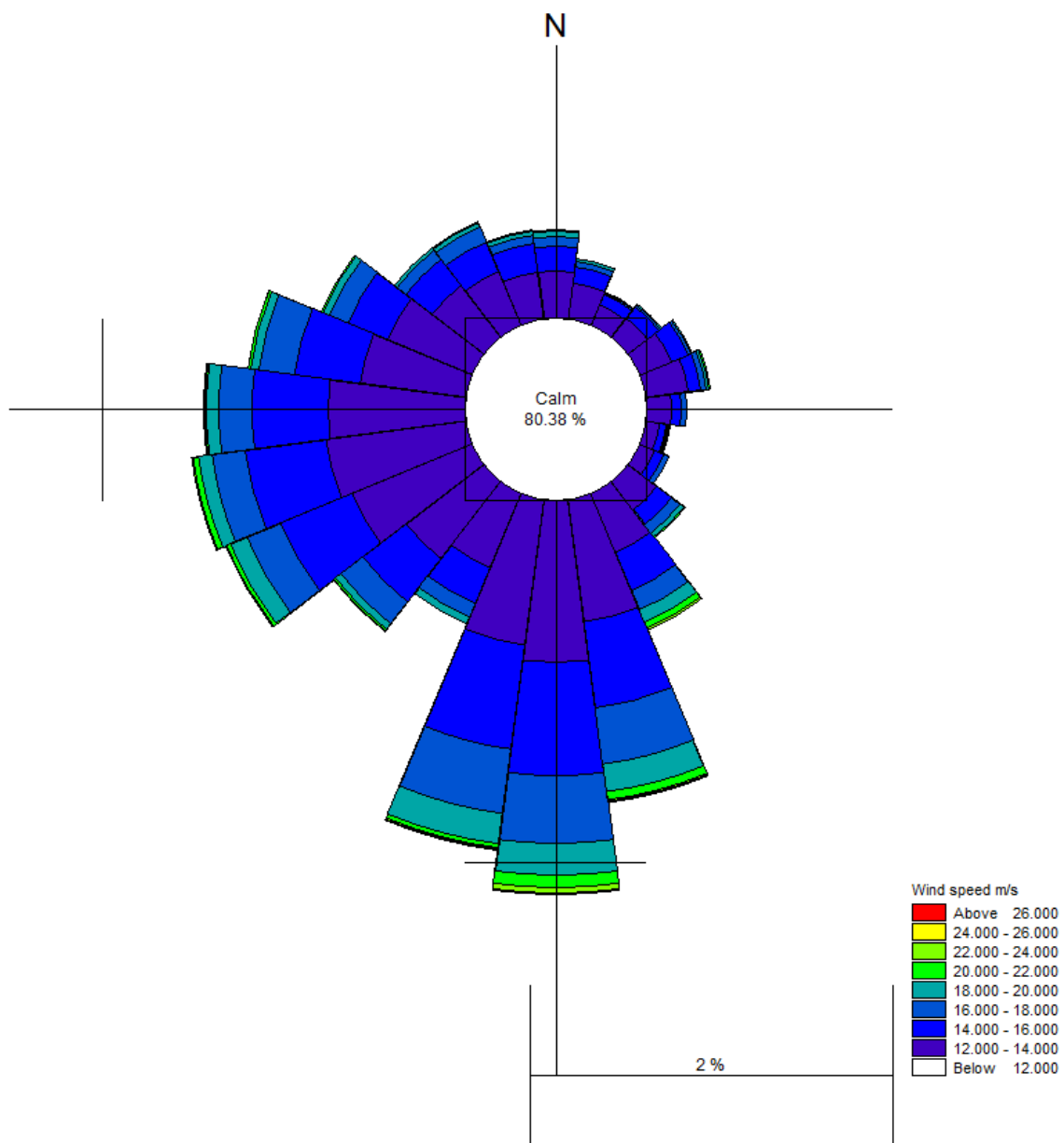

Figure 8.3.4: Wind Rose of the offshore wind climate above 12 m/s at the point 53.5° N 5.50° W, 1997-2011.

8.3.1 Extreme waves

Extreme value analysis (EVA) was undertaken by fitting a theoretical probability distribution to the 3 hourly data set generated from the UK Met. Office and ECMWF records for 1997-2011 wave heights. A partial duration series, also known as peak over threshold model was used to select the largest events that occurred within the dataset for each relevant directional sector. A Truncated Gumbel probability distribution was fitted to the datasets and using the Jackknife re-sampling technique. This approach was used to derive a series of return period wave heights for each directional.

Considering that the largest combined wind and swell waves that the beaches of Portrane and Rush are exposed to originate in the north east and the south west sectors, the significant wave height for various return period events for these sectors are presented in Table 8.3.1 and Table 8.3.2 below. The data for the remaining sectors are presented in *Appendix C*.

Table 8.3.1: Return periods for significant waves between 0 and 30 Degrees

Return Period N(years)	Significant wave height (H_{mo})	Mean Period (seconds)
1	1.75m	4.74
2	2.3m	5.43
5	2.9m	6.10
10	3.3m	6.51
20	3.7m	6.89
50	4.2m	7.34
100	4.6m	7.68
200	5.05m	8.05

Table 8.3.2: Return periods for significant waves between 180 and 210 Degrees

Return Period N(years)	Significant wave height (H_{mo})	Mean Period (seconds)
1	4.38m	7.49
2	4.72m	7.78
5	5.18m	8.15
10	5.46m	8.37
20	5.78m	8.61
50	6.2m	8.92
100	6.5m	9.14
200	6.82m	9.36

The storm wave characteristics for the 1 in 1 year return period storms from the south east to south west direction were calculated to have significant wave heights of 4.38 metres with mean wave periods of 7.49 seconds. The equivalent for a 1 in 50 year return period storm were waves with significant wave heights of 6.2 metres and mean wave periods of 8.92 seconds. A 1 in 100 year return period storm had significant wave heights of 6.5 metres with mean wave periods of 9.14 seconds.

8.3.2 Extreme wind

The extreme wind calculations for the north east and south west sectors were derived using the same technique described in section 8.2.1. The over water wind speed for 1 in 1 year return period storms from the south east to south west directions was found to be 22.5 m/s, whilst the value of the 1 in 100 year wind speed from the same direction was found to be 32.5 m/s.

Storms of such magnitude have a 63% chance of occurring once in 100 years and a 1% chance of occurring in any one year. Whilst these extreme storms are not representative of day-to-day conditions at the site, they are conditions that need to be considered when designing coastal defence structures.

The significant wind velocity for various return period events for the north east and south west sectors are presented in Table 8.3.3 and Table 8.3.4 below. The data for the remaining sectors are presented in *Appendix C*.

Table 8.3.3: Return periods for Wind Velocities between 0 and 30 Degrees

Return Period N(years)	Wind Velocity (m/s)
1	16.1
2	17.83
5	19.67
10	21.16
20	22.54
50	24.495
100	25.88
200	27.26

Table 8.3.4: Return periods for Wind Velocities between 180 and 210 Degrees

Return Period N(years)	Wind Velocity (m/s)
1	22.54
2	24.04
5	26.11
10	27.6
20	29.21
50	31.17
100	32.55
200	34.16

8.4 JOINT PROBABILITY ANALYSIS

The level of exposure at the shoreline to wave action is strongly influenced by tides. Wave heights at the shoreline are a function of water depth. This means that waves are generally limited by the depth of water inshore; as a result, larger waves will be broken further offshore. However, beaches can often experience large irregular increases in water levels called surges that are usually produced by the passage of cyclonic weather systems. These both increase the local water depth allowing larger waves to reach the shore and exposure to more landward sections of the shore to wave attack.

A joint probability analysis of wave heights and water levels or wind speeds and water levels was undertaken using the spreadsheet and simplified methodology derived during the JOIN-SEA project, which is described in section 5.7 of the DEFRA/Environment Agency RSD Guidance on Joint Probability Analysis, FD2308. This method involves selecting a correlation coefficient between each pair of variables. Although this is normally based on established relationships (for example wave height and water level) for a particular area, there are no pre-determined correlation coefficients available for the Irish coastline. Therefore, RPS made use of all wind, wave and tide gauge data available in order to derive joint event matrices between wave heights and water levels, or wind speeds and water levels, in order to determine an appropriate correlation coefficient for each of the directional sectors along each stretch of the study coastline. Due to the limited availability of long term tide gauge data around the study area RPS also made use of previous studies and experience in determining the most suitable correlation coefficients for each case.

Once an appropriate correlation coefficient was selected, the relevant set of Annual Exceedance Probabilities (AEP) water levels and wind speeds or wave heights were input into the JOIN-SEA spreadsheet for analysis. Water levels were taken from the ICPSS extreme water level outputs at various prediction points around the coastline, whilst the wave height data was derived during the EVA stage of this study, as described in section 8.3. AEP wind speeds were generally calculated using the Offshore Installations guidance.

Combinations of wave heights and water levels for joint AEPs of 50%, 20%, 10%, 5%, 2%, 1%, 0.5% and 0.1% were derived for each relevant directional sector at an appropriate offshore location. For every joint AEP, a series of six water levels with corresponding wave or wind conditions was output from the joint probability analysis to illustrate the complete joint probability spectrum.

The correlation between wave heights and water levels or wind speeds and water levels varied with storm direction; the joint probability analysis was therefore undertaken for a range of storm direction sectors. The correlation coefficients derived for each direction along the various coastlines are presented in Table 8.4.1

Table 8.4.1: Derived Correlation between Offshore Waves and water Levels

Direction	Correlation
0	
45	0.1
90	0.25
135	0.6
180	0.6
225	
270	
315	

At the study site, there was a strong correlation between the offshore wave heights and water levels for events from the south east and south, with less correlation from the east and the least correlation from the north east (see Figure 8.4.1).

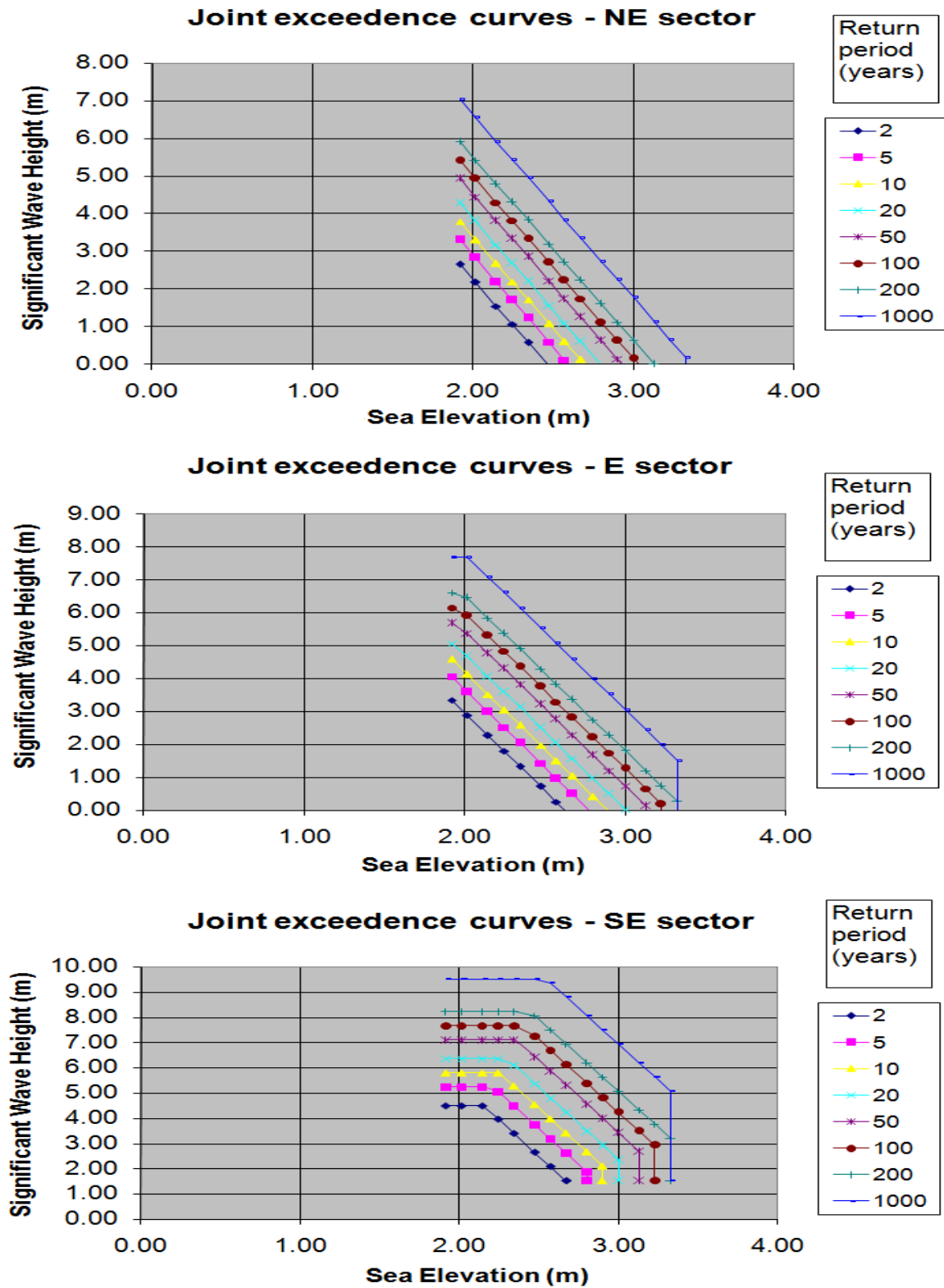

Figure 8.4.1: Joint Probability Curves, Extreme Waves and Water Levels

8.5 INSHORE WAVE CLIMATE

The inshore wave climate along the shore line was established by transforming offshore waves to the shore line by using the Mike 21 SW model. This is a spectral wave model that describes the propagation, growth and decay of waves in nearshore areas. The model takes account of the effects of refraction, shoaling, local wind generation and energy dissipation due to bottom friction and wave breaking. The input of the model includes the directional distribution of wave energy at the offshore boundary. The inshore wave climate time series was generated using the outer Portrane wave model shown in Figure 8.1.2.

The amount of wave dissipation on offshore banks and shoals on this part of the coastline is dependent on the prevailing waters levels. The tidal levels were gathered by the tidal gauges at Dublin and Howth Harbour, and then converted to MSL before being used in the SW model. An SW simulation was undertaken to transform 15 years of 3 hourly combined wave data to the shoreline to provide data for long term sediment movement at Portrane. The wave roses for the inshore wave climates of Portrane and Rush are presented below in Figure 8.5.1 and Figure 8.5.2.

In addition to the 15 year time series, specific wave events were transformed to the boundaries of the inner model for use in the modelling of the sediment transport regime and for the analysis of the impact of extreme wave events including the effect of climate change. Examples of the extreme wave transformation are shown in Figures 8.5.3 to 8.5.5.

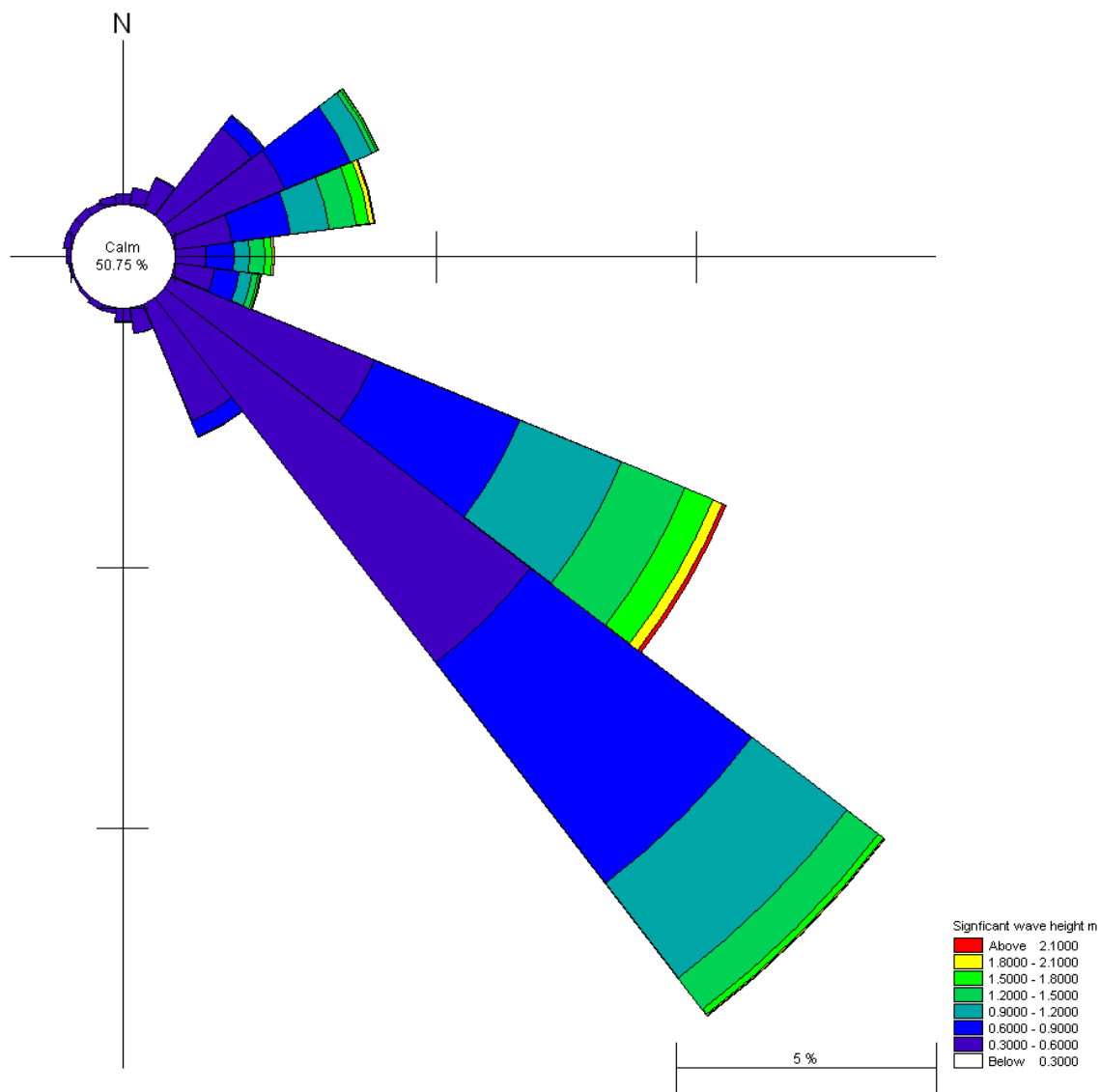

Figure 8.5.1: The inshore wave climate at Portrane beach – 15 year period 1997-2011.

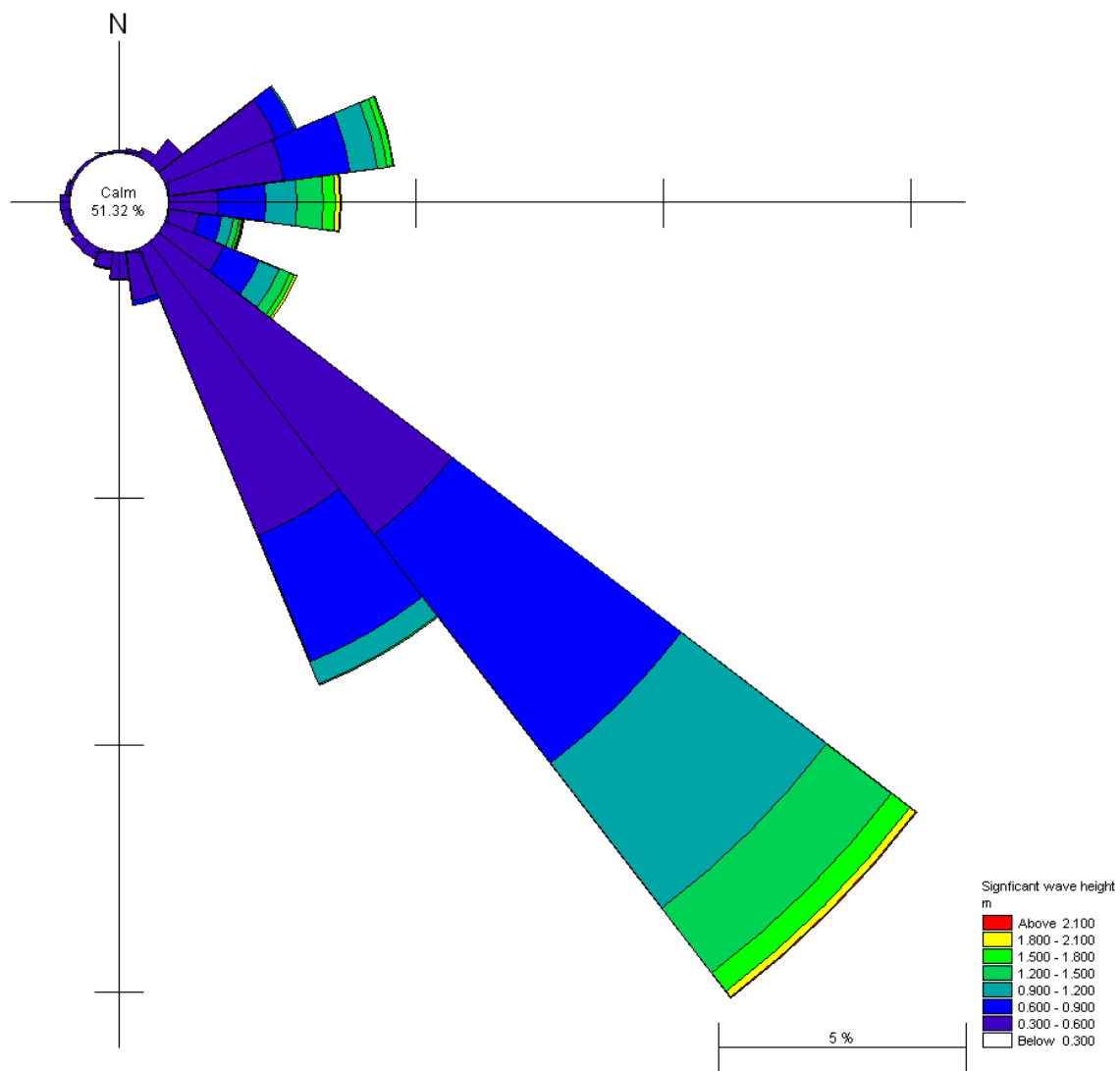

Figure 8.5.2: The inshore wave climate at Rush beach – 15 year period 1997-2011.

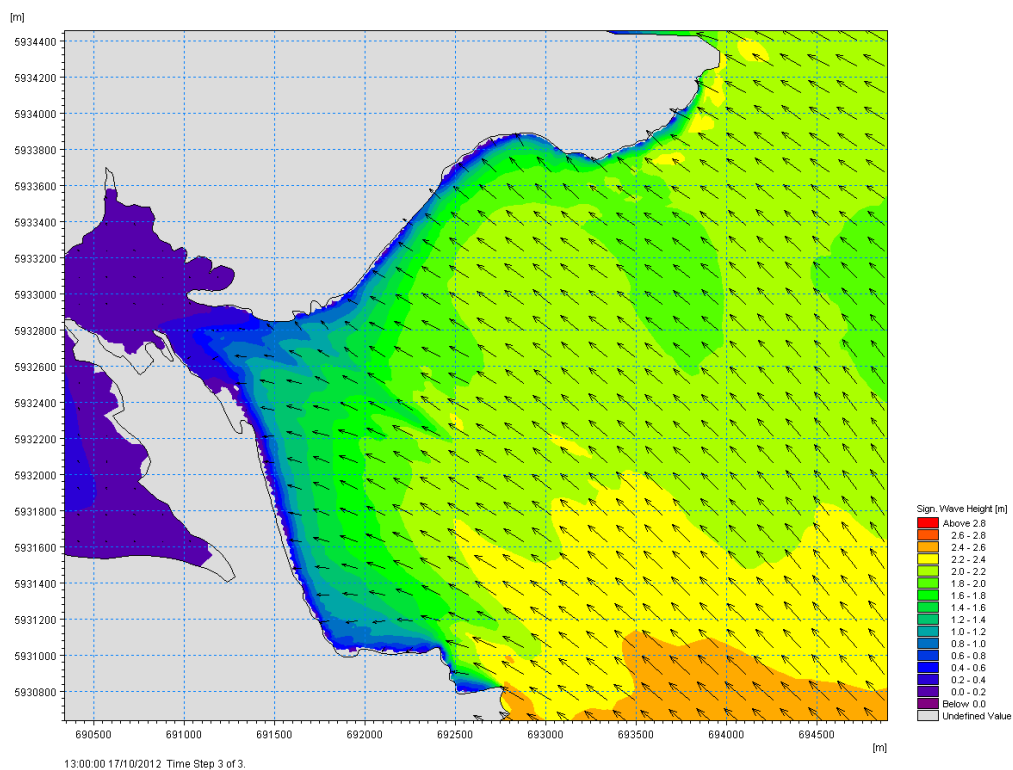

Figure 8.5.3 Significant wave height and mean wave direction – 1 in 5 year return period storm from 135°

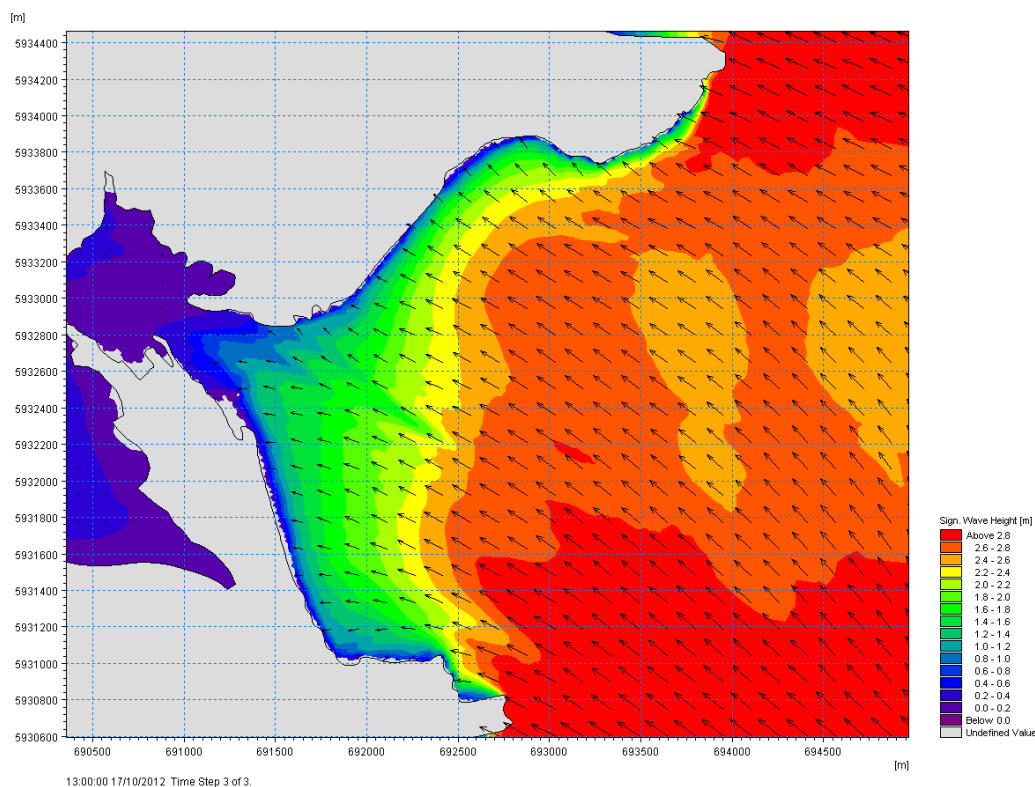

Figure 8.5.4 Significant wave height and mean wave direction – 1 in 50 year return period storm from 135°

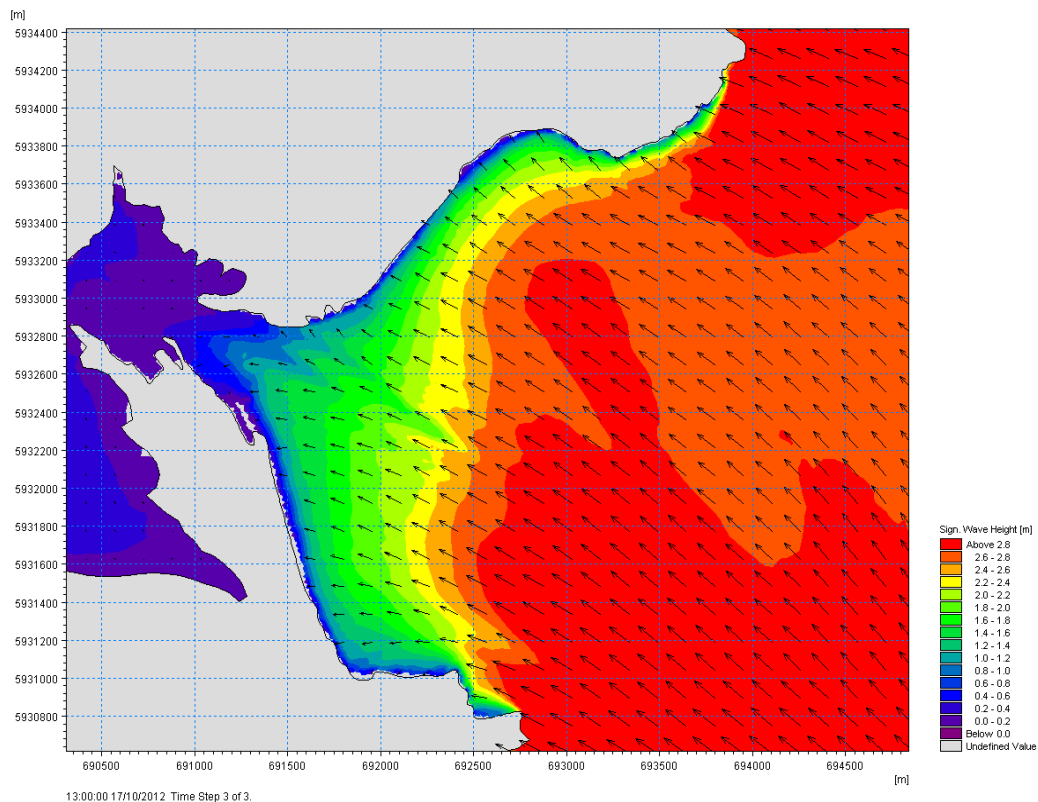

Figure 8.5.5 Significant wave height and mean wave direction – 1 in 100 year return period storm from 135°

8.6 LITTORAL CURRENTS AND SEDIMENT TRANSPORT

8.6.1 Overall Sediment Transport Regime

The section of the coastline between Rush and Portrane forms a mini sub cell within the east coast sub cell from Howth to Skerries. The beach is contained between the rocky headlands at Rush and Portrane and the wave climate and tidal regime to seaward of the beach is influenced by Lambay Island and its associated Frazer and Hoskyn Banks. There are extensive beaches to the south at Malahide and Portmarnock but only pocket beaches to the north. The coastal process study undertaken by KMM in 1998 showed that there was potentially more sediment drift past the Portrane headland from the south during an average year than was transported north out of the system past the Rush headland. The net gain in sediment quantity to the Portrane-Rush beach system in an average year was calculated at 4,240 m³ per year.

The Rogerstown Estuary exerts a strong influence on the sediment regime of the Rush and Portrane beaches with tidal currents of up to 1.4 m/s in the channel into the Rogerstown Estuary. The sediment transport regime varies rapidly around the entrance channel requiring the use of two dimensional sediment transport models to simulate the overall regime. The amount and nature of the sediment transport around the Portrane and Rush beaches is strongly influenced by the wave activity and the majority of the changes in the beaches and dunes only occur during significant wave events.

8.6.2 Littoral Current and Sediment Transport Simulations

The littoral current and sediment transport modelling was undertaken using the coupled wave, tide and sediment transport Mike21 flexible mesh model. The bathymetry and mesh of the model is shown in Figure 8.1.3 and Figure 8.1.4. The model was run for gales from the north east, south east and south directions with the wave climate profiles and tidal levels based on historic events. These simulations were used to derive an understanding of the littoral currents and resulting movement of sediments around the beaches under a range of climatic conditions.

As can be seen from the inshore wave roses, the dominant wave direction at the Portrane and Rush beaches is from the south east. Thus, the majority of the sediment movement occurs during south and south easterly gales. Figure 8.6.1 to Figure 8.6.3 show the littoral currents (left hand diagram) and sediment transport patterns (right hand diagram) at high water, mid ebb and mid flood during a south easterly gale. The overall patterns are broadly similar during a southerly gale.

During the upper part of the tidal cycle the drift along the upper Portrane beach is in a northerly direction and is in a westerly direction along the upper part of the western section of the Rush Beach. Sediment is also being fed north westerly towards the Portrane beach from the head land at Portrane. By mid ebb, when the ebb jet from the estuary becomes established, sediment is carried out by the estuary ebb flow and moves north towards the headland at Rush. At the same time there is also a small amount of northerly drift along the upper part of the southern section of the Portrane beach.

Due to the phase difference between the tides in the Rogerstown estuary and the Irish Sea, the main flood into the estuary occurs after the time of mid flood level. During south easterly gales there is little sediment movement along the beaches at Portrane and Rush at the time of flood, however sand is carried towards both beaches in a north west to north direction.

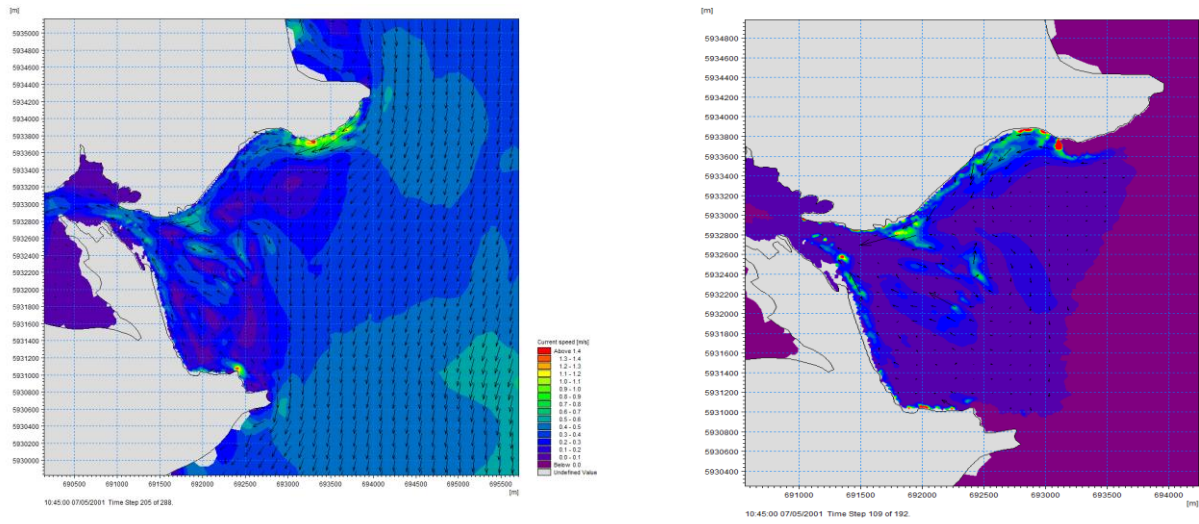

Figure 8.6.1: SE Gale - littoral currents and sediment transport at high water

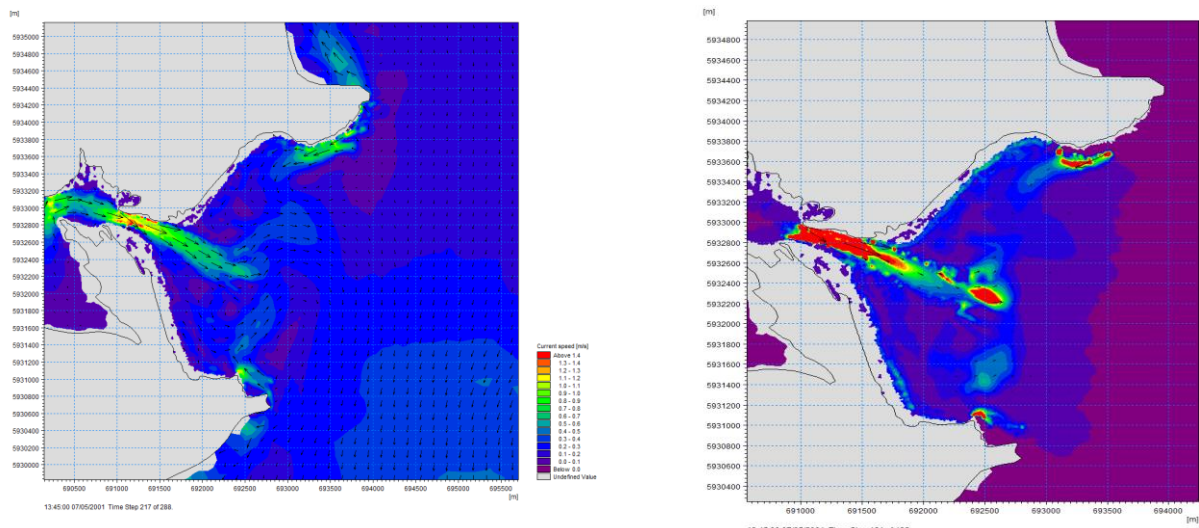

Figure 8.6.2: SE Gale - littoral currents and sediment transport at mid ebb

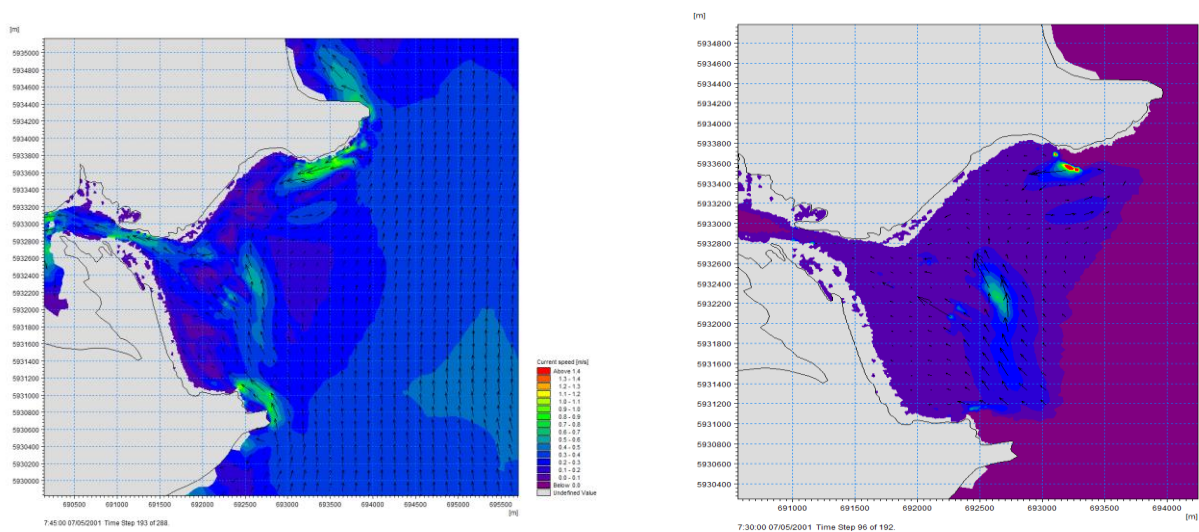

Figure 8.6.3: SE Gale - littoral currents and sediment transport at mid flood

During north easterly gales the drift is generally around the bay in south west to south direction with the main sediment transport concentrated in the lower part of the beach. However, during the upper part of the tidal cycle there a northerly drift along the central and southern sections of the upper Portrane beach and sand is also transported to southern end of this beach along the shoreline running west from the Portrane headland.

Overall, the model analysis indicates that the sediment drift regime has not changed since the analysis undertaken in 1998. There is generally a northerly drift along the upper Portrane beach and a westerly drift along the western section of the Rush beach. This sand that enters the channel into the Rogerstown estuary is then carried out by the ebb jet is fed back to the beaches such that the beach system is in a dynamic equilibrium under the current climatic conditions.

8.6.3 Aeolian Transport

In a healthy beach/dune environment, dry sand from the upper beach is transferred to the dune system by onshore winds. During storm events erosion allows sand stored and retained in the dunes by vegetation to be returned to feed the beach. If vegetation cover is removed or damaged by storms or human activity, large quantities of sand may be blown away and lost to the beach dune system.

Although the dunes along the northern section of the Portrane beach and most of the Rush beach have reasonably good vegetation cover at present, the middle and southern sections of the Portrane beach have areas where there is exposed sand along the dune face. Thus, planting and fencing in these areas would greatly assist the natural post storm regeneration of the dunes in these areas.

Dry sand on the upper beach will be subject to aeolian transport. The size of the beach sand grains at Portrane and Rush (0.18 – 0.2mm) means that saltation will be the most significant mode of aeolian transport. The threshold wind velocity for the commencement of transport will be about 5.5 m/s; above this velocity the rate of transport will be proportional to the cube of the wind speed. Thus, during onshore winds of Beaufort Force 4 and above, considerable quantities of sand can be transferred from the upper dry beach to the dunes. Based on the 15 years of wind records from 1997 to 2011, with suitable reduction for the proximity of the land, these conditions are likely to occur for about 19% of the time at the Portrane beach and 30% of the time for the Rush beach in an average year.

8.7 SEA LEVEL RISE AND ASSOCIATED IMPACTS

The Office of Public Works (OPW) have recently issued guidelines for the assessment of the effects of climate change. They recommended that two future scenarios should be assessed to examine the future effects and impacts of climate change. These scenarios are the Mid-range Future Scenario (MRFS), in which sea level is expected to rise by 500mm by 2100 and the High-End Future Scenario (HEFS), in which the sea level is expected to rise by 1000mm by 2100.

The most significant impact of sea level rise will be to enable the wave heights that can attack the dunes to increase for any particular return period. Return period events from 1 in 1 to 1 in 200 years were modelled for both the MRFS and the HEFS values of sea level rise by 2100. Examples of the impact of sea level rise for a 1 in 50 year return period event from the south east are shown in Figure 8.7.1 to Figure 8.7.3.

It can be seen from these figures that sea level rise will increase the energy of the wave climate approaching the dunes. Assuming no human interference in terms of the installation of coastal protection works then with increasing sea levels the shoreline will naturally tend to recede to re-establish the equilibrium between the water depth and wave climate that currently exists along the dune frontage. The amount of dune recession was calculated by allowing the dunes to recede until the stable beach dune profile was re-established at the new water levels.

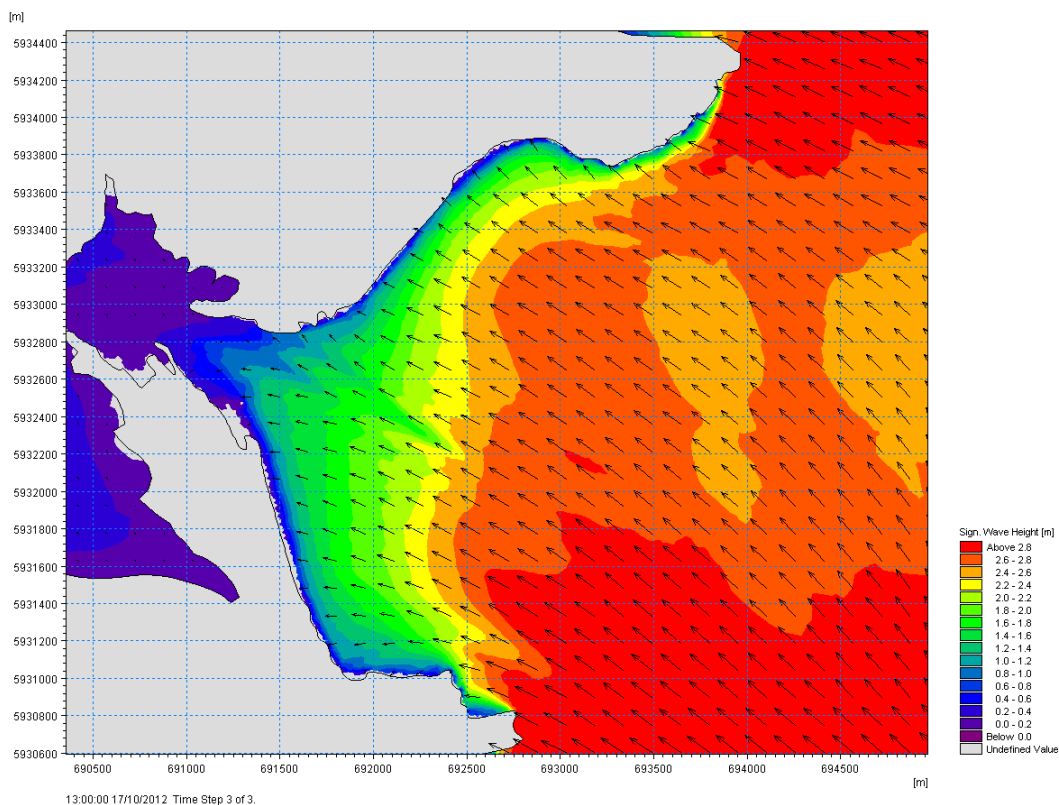

Figure 8.7.1: Significant wave height and mean wave direction 1 in 50 year return period event at 2013 water levels

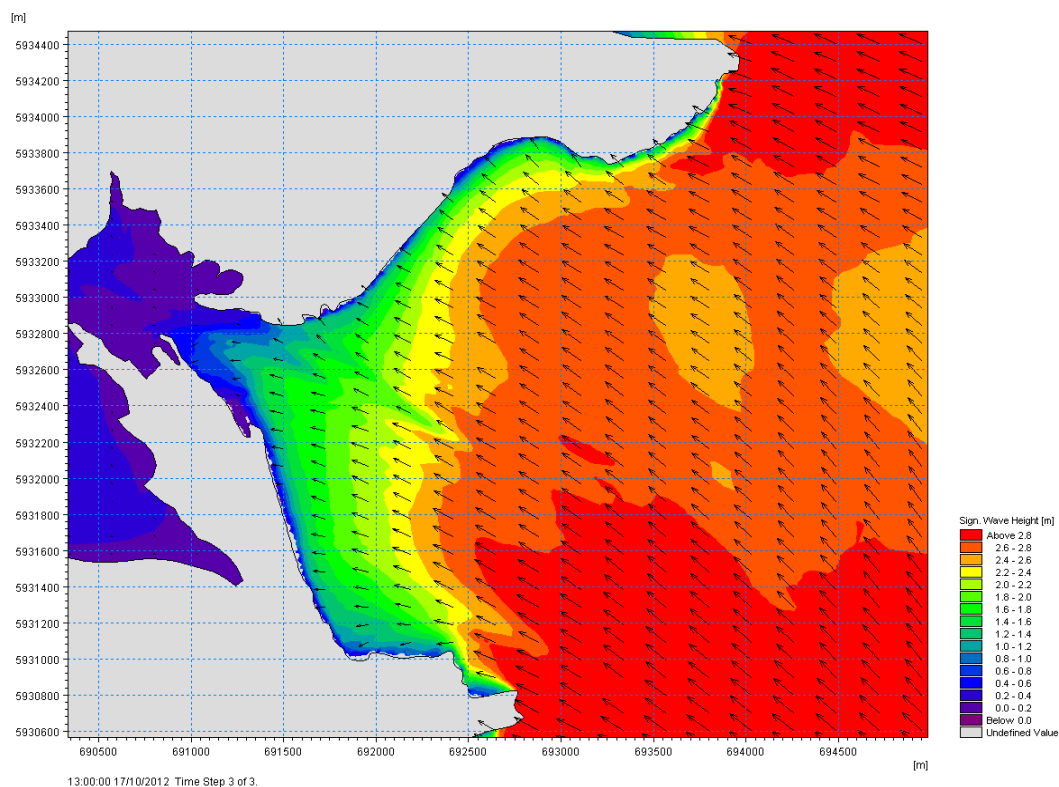

Figure 8.7.2: Significant wave height and mean wave direction 1 in 50 year return period event at 2100 water levels with 0.5m sea level rise

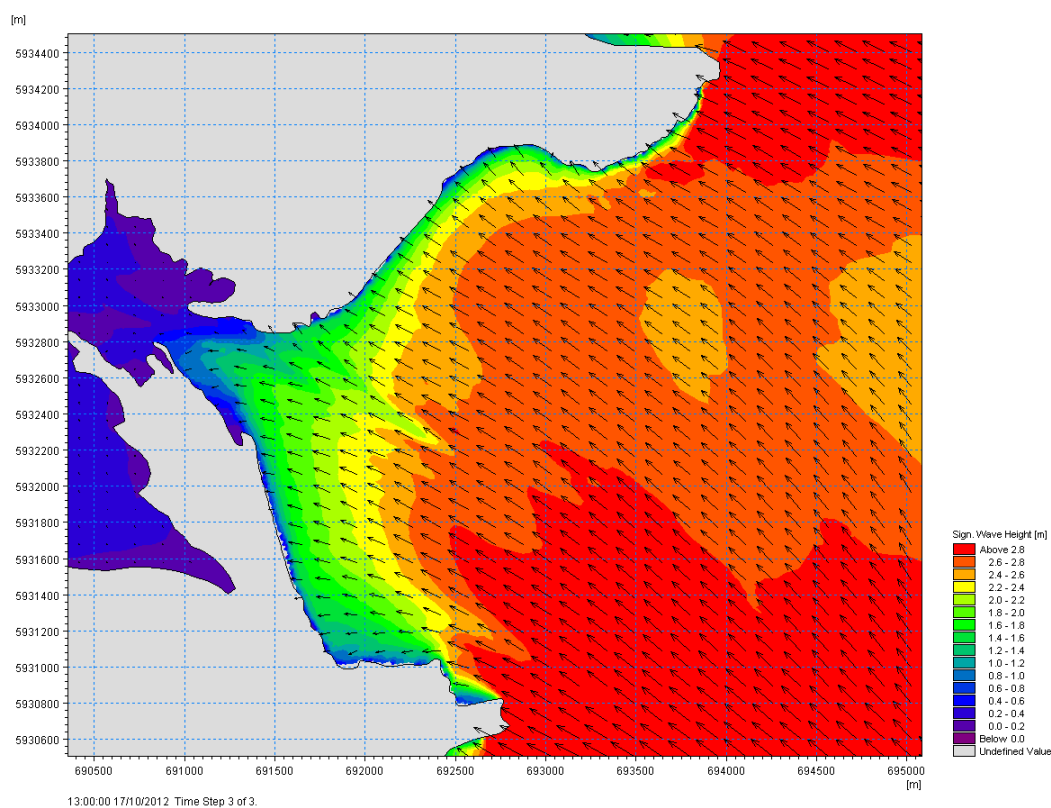

Figure 8.7.3: Significant wave height and mean wave direction 1 in 50 year return period event at 2100 water levels with 1.0m sea level rise

9 CURRENT AND FUTURE SCENARIO COASTAL CHANGE MAPS

The beach and dunes of Portrane and Rush are both dynamic systems that respond directly to hydrodynamic changes, including those imposed by climate change. The expected rise in sea level for both the MRFS and HEFS and the resulting impact on the dune morphology at both sites has been investigated by changing the existing present day model to account for the climate changes predicted by the OPW. The predicted changes to the current study area are presented in the following sections.

9.1 PORTRANE

At Portrane, it is expected that for the MRFS predicted by the OPW, in which the sea level rises by 500mm, the greatest changes along the dune face will occur at middle of the beach (Zone 2). It is expected that due to erosion, the dune face will regress by approximately 24 metres in this region by 2100. For the HEFS, in which the sea level is expected to rise by 1000mm, Zone 2 is likely to retreat west by 48 metres by 2100. Furthermore, it is likely that the fore dune will erode and expose residential properties located in the Burrow, to both wave and tidal conditions. The amount of sand eroded from the receding dunes is relatively small in comparison to the area of the beaches so there will be no significant change in the sediment regime of the area.

Similarly for Zone 1, which is largely a salt marsh habitat, further erosion is likely to take place. It is expected that the current vegetation line will retreat west by approximately 20 metres by 2100. However, a sand bank that is currently developing east of this region may delay the erosion in this area. It is expected that for the HEFS, the dune is likely to move west by 40 metres by 2100.

It is expected that the erosion of the dune at the southern section of Zone 3 will be slower than the erosion experienced in Zones 1 and 2, with the dune face retreating by approximately 9 metres by 2100. This is because that unlike Zones 1 and 2, the shoreline in this region is not directly exposed to wind and swell energy originating in the south and south east sectors. Furthermore, the presence of a stony upper shore, to an extent, protects the shoreline from erosion. However, the northern section of Zone 3 is expected to erode at the same rate as Zone 2, with the dune retreating west by approximately 24 metres by 2100. For the HEFS, the southern section of Zone 3, it is likely the vegetation line will move west by 18 metres by 2100, whilst the northern section of the dune will move west by approximately 48 metres by 2100.

Overall it can be stated the dune system along the Portrane beach is very likely to erode and retreat west, for both the MRFS and HEFS due to the increased exposure to wind and wave and tidal action. The current vegetation lines and predicted vegetations lines for both the MRFS and HEFS can be observed in Figure 9.1.1.



Figure 9.1.1: Current and future scenario vegetation lines for Portrane Beach.

9.2 RUSH

The data produced by the various models suggests that for both the MRFS and the HEFS the western end of the beach will retreat by 15 and 30 metres respectively, particularly in front of the golf course. For the eastern end of the Rush beach, it is likely that the beach accretion, due to the nature of the sediment transport regime, will compensate for the impact of sea level rise by the end of the century.

Overall it is likely that the dune system along the Rush beach will remain at its current location at the eastern end of the beach and recede by between 15 to 30 metres by 2100. The current vegetation lines and predicted vegetations lines for both the MRFS and HEFS can be observed in Figure 9.2.1.



Figure 9.2.1: Current and future scenario vegetation lines for Rush Beach.

10 RISK ASSESSMENT

RPS conducted a detailed risk assessment of the current and anticipated future vulnerability (for the MRHS and MEFS) of the study area to coastal erosion over two timescales; 2050 and 2100. The risk assessment will be based on the extent of areas at risk from the coastal change as shown on the coastal change maps displayed in Figure 9.1.1 and Figure 9.2.1. RPS will quantify the risk in terms of the following:

- In terms of human health and life (social)
- Environmental
- Cultural heritage
- Economics
- Infrastructure.

In order to deliver a more accurate risk assessment for the coastline of Portrane, Zones 2 and 3 that were originally identified in section 4.1 were further divided into sub sections. These subsections are displayed in Figure 9.2.1. It was also decided that it was not necessary to subdivide Rush beach into sections as no assets were at risk from erosion over the full length of the beach.

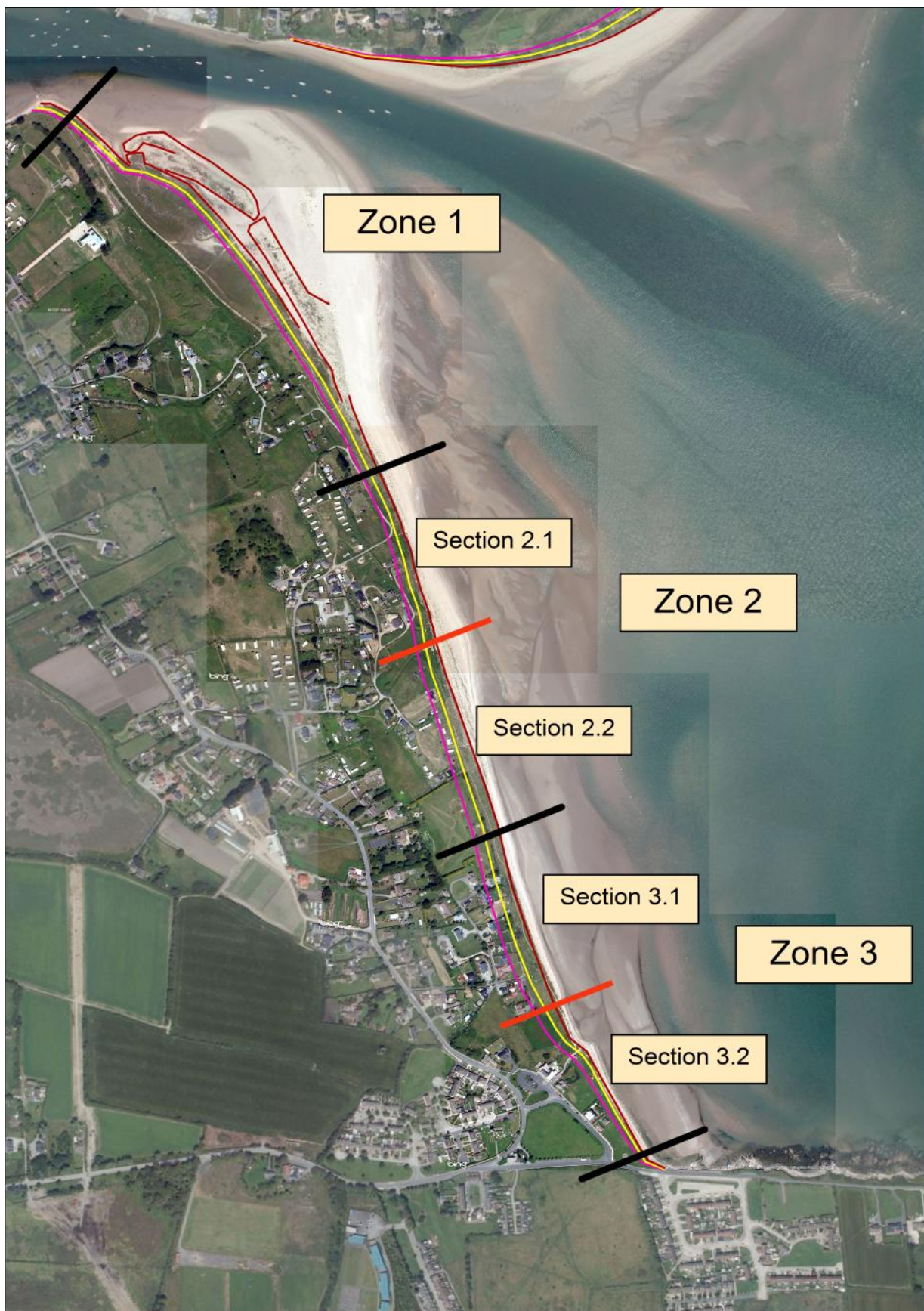

Figure 9.2.1: Zones 2 and 3 of Portrane beach were further divided into sub sections for the Risk Assessment.

10.1 PORTRANE

Within the Portrane area, the principal threat from coastal erosion relates to the residential property located in the Burrow behind the fore dune in Zone 3, section 3.1. For the MRFS the vegetation line is expected to regress by 8 to 24 metres by 2100. Although it is also expected that the width of the intertidal zone may be decreased along the shoreline Portrane beach as a direct result of the rise in sea level, which is driven by climate change. This may potentially impact the recreational use of the beach.

In this scenario, it is expected that only one residential property (Property D) located in the section 3.1 of Zone 3 will be put at a substantial risk. Currently, the property is approximately 19 metres behind the existing vegetation line. Based on local property tax valuation guide issued by the Irish Tax and Customs office and the recent market prices of detached residential property in the Portrane area, the property at risk is expected to have a market value between €339,000 and €350,000.

The Fingal East Meath Flood Risk Assessment and Management Study (FEM-FRAM) flood risk management plan concluded there is a limited flood risk at Portrane as a result of tidal flooding propagating up the Rogerstown Estuary and Portrane would not accrue any economic damage for a 0.5% flood event.

In the HEFS, 10 detached residential properties were identified as being at risk of significant structural failure as a result of coastal erosion. One of these properties (Property A) is located in section 2.1 of Zone 3, a further 2 (Properties B and C) are in section 2.2 of Zone 2 whilst the remaining 7 (Properties D to K) are all located in section 3.1 of Zone 3. The above-mentioned properties at risk in Zone 2 and Zone 3 are displayed in Figure 10.1.1 and Figure 10.1.2 respectively.

Considering that the market value of a detached residential property based on local property tax valuation guide issued by the Irish Tax and Customs office and the recent market prices of detached residential property in the Portrane area is €339,000 and €350,000 then the combined market value of the properties at risk in Section 2.1 of Zone 2 would be between €339,000 and €350,000. The combined present market value of the properties at risk in Section 2.2 of Zone 2 would be between €687,000 and €750,000 whilst those in Section 3.1 of Zone would have the highest combined market value of €2,370,000 and €2,450,000. Overall, the combined market value of all the properties at risk is estimated to be between €3,729,000 and €3,850,000.



Figure 10.1.1: Properties identified as being at risk in Zone 2 of Portrane Beach



Figure 10.1.2: Properties identified as being at risk in Zone 3 of Portrane Beach

10.2 RUSH

The Fingal East Meath Flood Risk Assessment and Management Study (FEM-FRAM) flood risk management plan concluded that the Rush area is currently vulnerable to both tidal and fluvial flooding. The majority of the flooding is expected to occur at the downstream extent of the Rush West Stream, to the west of Rush town and Channel Road. The flood maps also indicated that a large urban area was at risk from flooding from a combination of fluvial and tidal flooding.

Overall, RPS has concluded that coastal erosion, including erosion resulting from the expected rise in sea level driven by climate change does not pose a significant threat to assets behind the dune system at Rush beach. Rush has thus been excluded from any further investigations and coastal protection management scenarios.

11 ENVIRONMENTAL ASSESSMENT

11.1 NATURA 2000 SITE AND THEIR CONSERVATION OBJECTIVES

The project has potential to interact with the qualifying interests of Rogerstown Estuary SAC and Rogerstown Estuary SPA. Qualifying interests for both sites are listed in Table 2.2.1, and derive from NPWS publications (2013a; 2013d).

11.2 ROGERSTOWN ESTUARY SAC

Rogerstown Estuary SAC (Site Code IE0000208)(see Figure 11.2.1)) was proposed as eligible for identification as a Site of Conservation Importance (SCI) in December 1999. Conservation objectives for this 586.47ha¹ SAC are described in NPWS (2013a). Appendix IV of the Rogerstown Estuary SAC Conservation Objectives supporting document (NPWS 2013b) contains a site report describing the Portrane dunes in some detail, the key objectives are presented in Table 11.3.1. This work was originally presented as part of Ryle *et al.* (2009). Section 4.4.1 of NPWS (2013b) notes in a discussion of maintaining the physical structure and functioning of the dunes that coastlines naturally undergo a constant cycle of erosion and accretion, and that there are two main causes of this; (a) those resulting from natural causes and (b) those resulting from human interference. Human interference is usually associated with changes in the sediment budget, either directly, through the removal of beach or inshore sediment, or indirectly, by impeding or altering sediment movement.

Whilst the process of coastal erosion is part of a natural tendency towards equilibrium with dunes forming naturally dynamic systems that require continuous supply and circulation of sand, the construction of physical barriers such as sea defences can interrupt longshore drift, leading to beach starvation and increased rates of erosion. The construction of physical barriers can interfere with the sediment circulation by cutting the dunes off from the beach resulting in fossilisation or over-stabilisation of dunes.

This is recognised in the national assessment of white and grey dune systems (NPWS 2013c) which notes that sea defence and coastal protection works (EU threat code J02.12.01) are a high category pressure on white dunes (white dunes) and a medium category pressure on fixed dunes (grey dunes). Fences and fencing (EU threat code G05.09) was ranked as a medium category pressure on white dunes, and not listed for grey dunes.

This project recommends that no long term engineering interventions are implemented, but that some interim measures are introduced. The long term recommendation is entirely complementary to the natural fluctuating dynamism of the dune systems at Portrane as recognised by NPWS (2013a, b).

The interim measures include removal and reinstatement of fencing at a 400 metre long area of grey dune at the southern end of the Burrow, Portrane.

These works are not considered to result in a threat to the grey dunes (2130) in respect of their range, area, structure or function. This annex habitat is currently assessed as having a favourable range and area at a national level (NPWS, 2013c). Overall structure and function at a national level is considered 'unfavourable-bad'. This is based on criteria being applied where >25% of the assessed feature results in an overall 'unfavourable-bad' determination. 74.9% of the sites sampled had a grey

¹ The area of the cSAC has been calculated as 5,864,651.5m² using the geodatabase file of the Rogerstown Estuary SAC polygon (v1.02) as published on the National Parks and Wildlife Service data maps viewer <http://webgis.npws.ie/npwsviewer/> on 21 June 2013.

dune resource in favourable condition, and 25.1% of the sites sampled had a grey dune resource in unfavourable-bad' condition.

Having considered all these factors, conservation objectives of the Rogerstown Estuary SAC are not likely to be adversely affected by the interim measures adopted.

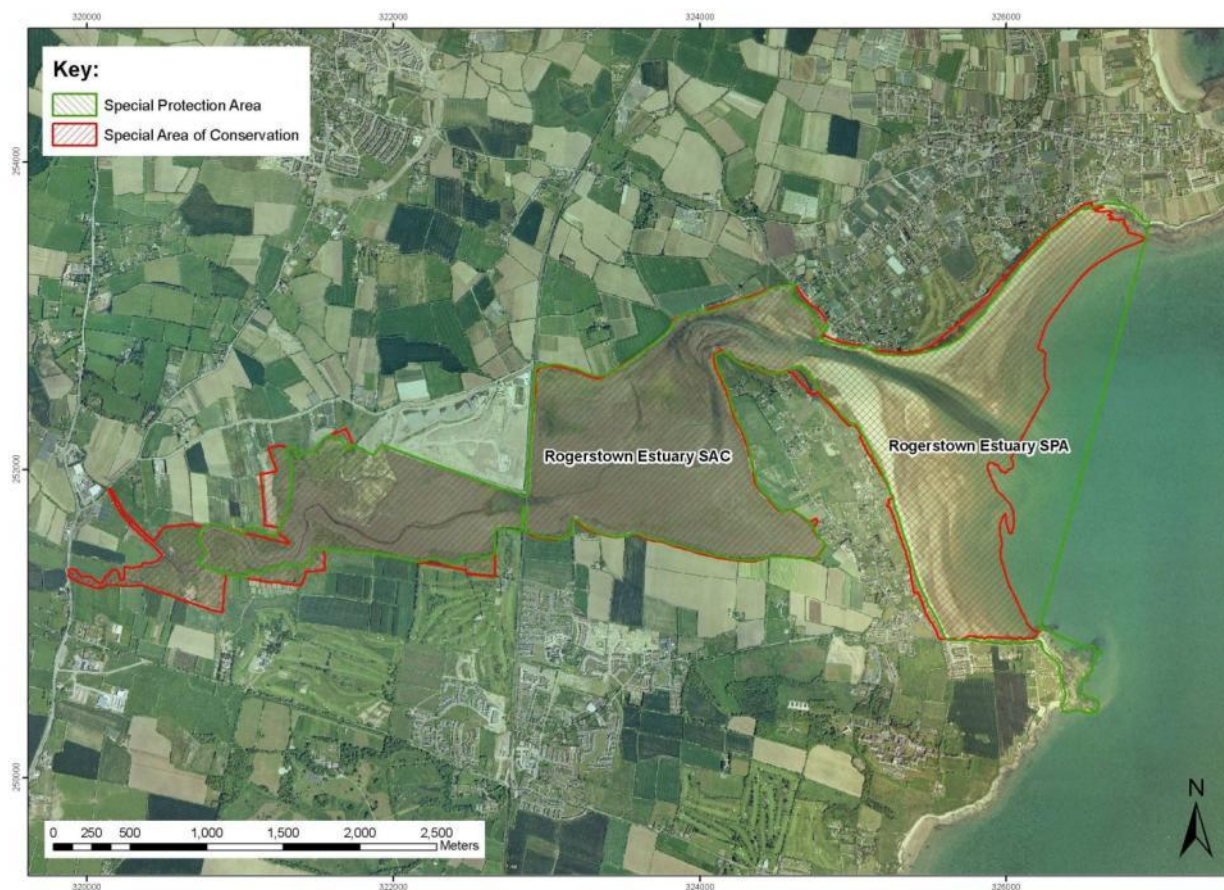

Figure 11.2.1: Rogerstown Estuary SAC and SPA boundaries

Table 11.2.1: Natura 2000 sites Located within the Zone of Influence of the proposed interim measures, Conservation Interests and Vulnerability/Threats

Natura 2000 Site		Habitat		Wintering Species		Vulnerability / Threats
Code	Name	Code	Name	Code	Name	
208	Rogerstown Estuary SAC	1130	Estuaries			<ul style="list-style-type: none"> • Landfilling • Pollution from landfill, sewerage and agriculture • Erosion of sand dunes
		1140	Mudflats and sandflats not covered by seawater at low tide			
		1310	<i>Salicornia</i> and other annuals colonizing mud and sand			
		1330	Atlantic salt meadows (<i>Glauco-Puccinellietalia maritimae</i>)			
		1410	Mediterranean salt meadows (<i>Juncetalia maritimi</i>)			
		2120	Shifting dunes along the shoreline with <i>Ammophila arenaria</i> (white dunes)			
		2130	Fixed coastal dunes with herbaceous vegetation (grey dunes)			
4015	Rogerstown Estuary SPA	[A999]	Wetlands			<ul style="list-style-type: none"> • Landfilling • Pollution from landfill, sewerage and agriculture • Erosion of sand dunes • Disturbance to wintering waterfowl from illegal shooting
				[A043]	Greylag Goose (<i>Anser anser</i>)	
				[A046]	Light-bellied Brent Goose (<i>Branta bernicla hrota</i>)	
				[A048]	Shelduck (<i>Tadorna tadorna</i>)	
				[A056]	Shoveler (<i>Anas clypeata</i>)	
				[A130]	Oystercatcher (<i>Haematopus ostralegus</i>)	
				[A137]	Ringed Plover (<i>Charadrius hiaticula</i>)	
				[A141]	Grey Plover (<i>Pluvialis squatarola</i>)	
				[A143]	Knot (<i>Calidris canutus</i>)	
				[A149]	Dunlin (<i>Calidris alpina</i>)	
				[A156]	Black-tailed Godwit (<i>Limosa limosa</i>)	
				[A162]	Redshank (<i>Tringa totanus</i>)	

Table 11.2.2: Qualifying Features and Conservation Objectives for Designation of Rogerstown Estuary SAC

Qualifying Feature	Representativity	Relative Surface	Conservation Status	Global Assessment	Description
1140 Mudflats and sandflats not covered by seawater at low tide	B	B	C	C	61% of SAC
1130 Estuaries	B	C	C	C	13% of SAC
1320 <i>Spartina</i> swards (<i>Spartinion maritima</i>)	D	-	-	-	10% of SAC
1330 Atlantic salt meadows (<i>Glauco-Puccinellietalia maritima</i>)	B	C	C	C	4% of SAC
1410 Mediterranean salt meadows (<i>Juncetalia maritimi</i>)	B	C	C	C	4% of SAC
2120 Shifting dunes along the shoreline with <i>Ammophila arenaria</i> ("white dunes")	C	C	C	C	1% of SAC
2130 * Fixed coastal dunes with herbaceous vegetation ("grey dunes")	C	C	C	C	1% of SAC
1310 <i>Salicornia</i> and other annuals colonizing mud and sand	B	C	C	C	1% of SAC

11.3 ROGERSTOWN ESTUARY SPA

Rogerstown Estuary (Site Code IE0004015) is an important waterfowl site, with a population of Brent Geese of international importance. A further 16 species have populations of national importance. The presence of a significant population of Golden Plover is noteworthy as this species is listed on Annex I of the EU Birds Directive. The estuary is a regular staging post for autumn migrants, especially Green Sandpiper, Ruff, Little Stint, Curlew Sandpiper and Spotted Redshank.

Little Tern has bred at the outer sand spit, but much of the nesting area has now been washed away as a result of erosion. The maximum number of pairs recorded was 17 in 1991. Ringed Plover breed in the same area. The outer part of the estuary has been designated a statutory Nature Reserve and a Special Protection Area under the EU Birds Directive. The inner estuary has been damaged by the refuse tip which covers 40 hectares of mudflat. This site is a good example of an estuarine system, with all typical habitats represented, including several listed on Annex I of the EU Habitats Directive. The qualifying interests of the SPA site are listed in Table 11.3.1.

A copy of the Natura 2000 Standard Data form and Conservation Objectives can be found in *Appendix D*

Table 11.3.1: Qualifying Features and Conservation Objectives for Designation of Rogerstown Estuary SPA

Feature Type	Feature	Designation Population	Population	Conservation	Isolation
Species	Greylag Goose <i>Anser anser</i>	87	B	A	B
Species	Brent Goose <i>Branta bernicla hrota</i>	1194	B	A	C
Species	Shelduck <i>Tadorna tadorna</i>	781	B	A	C
Species	Shoveler <i>Anas clypeata</i>	72	B	A	C
Species	Oystercatcher <i>Haematopus ostralegus</i>	1794	B	A	C
Species	Ringed Plover <i>Charadrius hiaticula</i>	187	C	B	C
Species	Grey Plover <i>Pluvialis squatarola</i>	343	B	A	C
Species	Knot <i>Calidris canutus</i>	2159			
Species	Dunlin <i>Calidris alpina alpina</i>	3128	B	A	C
Species	Black-tailed Godwit <i>Limosa limosa</i>	212	C	A	C
Species	Redshank <i>Tringa totanus</i>	674	B	A	C
Habitat	Wetlands	N/A	N/A	N/A	N/A

Conservation Objectives

Objective 1: To maintain the favourable conservation condition of the waterbird Special Conservation Interest species listed for Rogerstown Estuary SPA, which is defined by the of attributes and targets outlined in Table 11.3.2.

Objective 2: To maintain the favourable conservation condition of the wetland habitat at Rogerstown Estuary SPA as a resource for the regularly-occurring migratory waterbirds that utilise it. This is defined by the of attributes and targets outlined in Table 11.3.2.

Table 11.3.2: Rogerstown Estuary SPA Conservation Objectives

Feature	Attribute	Measure	Target	Notes
Wintering Species	Population Trend	Percentage Change	Long term population trend stable or increasing	Population trends are presented in part four of the conservation objectives supporting document
	Distribution	Number and range of areas used by waterbirds	No significant decrease in the range, timing or intensity of use of areas by ringed plover, other than that occurring from natural patterns of variation	Waterbird distribution from the 2011/2012 waterbird survey programme is discussed in part five of conservation objectives supporting document
Wetland Habitat	Habitat area	Hectares	The permanent area occupied by the wetland habitat should be stable and not significantly less than the area of 646 hectares, other than that occurring from natural patterns of variation	The wetland habitat area was estimated as 646ha using OSi data and relevant orthophotographs.

12 OPTIONS AND FEASIBILITY ASSESSMENT

12.1 INTRODUCTION

The evidence from historical records show that the dynamic system comprising of the dune and the beach at the Burrow, Portrane has been subject to both accretion and erosion over the past 40 years. Furthermore, the accretion and erosion events appear to be cyclic in nature. Based on the potential risks to Portrane identified in section 10, RPS undertook an options and feasibility assessment. The assessment was based on the latest Flood and Coastal Risk Management Appraisal Guidance (FCERM) (EA,2100), which provides a methodology to undertake effective assessments. In principle the main objectives of the assessment undertaken by RPS were to:

- Consider all possible management options and measures
- Consider both structural and non-structural options
- Provide a sense check on potential options
- Consider approximate costs of both capital and longer term maintenance work
- Consider all of the above for short (2015), medium (2050) and long-term (2100) scenarios
- Ensure any options recommended:
 - are operationally robust
 - minimise economic risk
 - minimise risk to human health and life
 - minimise risk to community
 - minimise risk to, or enhance, social amenity
 - minimise risk o environmental pollution
 - avoid damage to, and where possible enhance the flora and fauna of the study area
 - avoid damage to, and where possible enhance landscape character and visual amenity within the study area
 - avoid damage to, or loss of features of cultural heritage importance and their setting and heritage value within the study area

The main purpose of the options and feasibility assessment is to develop a suitable coastal defence policy for the shoreline of Portrane. Four key issues that are presented below, need to be addressed in the appraisal of such policies:

- Coastal processes, including the historic and future evolution of the coastline, existing coastal data and studies.
- The Natural environment, including the implications of the Habitats Directive and biodiversity targets on shoreline management.
- Current and future land use, including current and future development proposals, agricultural and forestry issues, ports and harbour operations, aggregate and other dredging operations, recreational and tourism.
- Existing coastal defences, including the purpose and ownership/responsibility of defences, the condition, performance and residual life of existing defences, and other factors such as the availability of beach renourishment material to meet the present and future needs.

As no key policy driver has been previously identified for the coastline of Portrane, RPS conducted an initial screening process to briefly review the technical feasibility and economic justification of all generic management options including 'Hold the line', 'Advance the line' and 'Managed realignment'. The output of this initial screening process is shown in Table 12.1.1.

Table 12.1.1: Initial review of Coastal Protection policies for Portrane

Summary description Portrane	A sandy spit that separates the outer Rogerstown Estuary from the Irish Sea. Occupied by numerous holiday homes and several residential properties that are accessed via minor roads and tracks.		
Policy	Short term (2015)	Medium term (2050)	Long term (2100)
Hold the Line	To be appraised. Will protect the residential property behind the fore-dune in the middle of beach and reduce future flood risks to Burrow		
Advance the Line	No benefits, and potential environmental impacts would result from the development of seaward defences		
Managed Realignment	To be appraised. Will protect the residential property behind the fore-dune in the middle of beach and reduce future flood risks to Burrow		
Do Nothing	To be appraised. Limited potential process benefits. Potential long term economic gains. However, likely lose of 10 residential properties in long term		

Following the outcome screening process, RPS then fully investigated the 'Hold the Line', 'Managed Realignment' and 'Do nothing' policies for the shorelines of Portrane. These generic policy options are detailed below (DEFRA 2001) (FCDPAG3):

- **Hold the Line**

Improve or maintain the standard of protection provided by the existing defence line. This policy includes situations where works or operations are undertaken in front of and behind the existing defences (e.g. beach renourishment, additional toe protection, construction of offshore breakwaters to control beach response etc), to improve or maintain the standard of protection provided by the existing defence line.

- **Managed realignment**

Identification of a new line of defence and where appropriate constructing new defences landward of the original defences or, in this case, undertake measures to control the rate of coastal retreat particularly in relation to sea level rise.

- **Do nothing**

Where there is an existing defence, walk away: cease all maintenance, repairs and similar activities immediately. Where there is no existing scheme, do nothing, do not intervene natural processes.

12.2 THE 'DO NOTHING' SHORELINE OPTION

The key aim of considering the 'Do nothing' scenario is to understand the potential changes to the coastline from the current and future coastal processes. This is linked to an understanding of historical erosion and sea level trends, in addition to other examples of similar coastal geomorphological settings and applying these to the protection afforded by the current condition of any existing structures.

Coastal erosion has been projected into the future based on recession scenarios of the coastline within a GIS system. From this assessment, it has been identified when various assets in terms of property, building, roads, utilities and environmental features are impacted. This has been done for short (2015), medium (2050) and long-term (2100) time scales.

12.2.1 Short term impacts (year 2015)

By adopting a 'Do nothing' approach, contemporary erosion rates would continue from the south end of the beach to middle of the beach. The northern end of Portrane beach may accrete in the short term due to the littoral drift of sediment from the southern end of the beach, but will remain liable to erosion during storm events. Overall, a change in the fore-dune condition should be expected in Zone 2, along with possible plan view changes to the dune system. Little or no risk in economic/human terms is expected during this period.

12.2.2 Medium term impacts (year 2050)

It is expected that sea-level rise will begin to significantly affect the stability of the fronting dune system, particularly in the middle section of the beach. The vegetation line will likely regress by up to 12 metres in the MEFS and by up to 24 metres in the HEFS, in both cases the site of one private residential dwelling (Property D, Figure 10.1.2) located in the upper end of Zone 3 will no longer be sustainable and the property will be deemed uninhabitable. In Zone 1, alteration to the salt marsh habitat is expected.

12.2.3 Long term impacts (year 2100)

With the exact timing dependant on the magnitude of the effects of climate change, particularly the rise in sea levels, it is expected that the current vegetation line will retreat by up to 24 metres under the MRFS and 48 metres under the HEFS. If climate change occurs at the rate predicted by the MEFS, then it is likely that the only property identified as being at risk from erosion would be property D. Conversely, if climate change was to occur at the rate predicted by the HEFS, then it would be very likely that properties A-J would be lost to erosion. It is also expected that localised breaching of the fore dune located in the middle of the beach may occur, thus exposing the Burrow to an increased risk of localised flooding. The salt marsh habitat located at the northern end of Portrane would also be lost as a result of the rise in sea level.

In general, doing nothing will ensure that the objectives of current Natura designations will be fulfilled. The natural morphodynamics of the Rogerstown Estuary and the dune system of Portrane will change the appearance of the fore-dunes along the beach of Portrane and the key habitats of importance, including the salt marsh at the northern end of the Portrane beach.

12.3 PRELIMINARY OPTIONS APPRAISAL

Following the Risk assessment of Portrane beach and a full assessment of the 'Do nothing' option, a long list of potential measures were derived for each Zone and sub section (if applicable). All reasonable options for the study area were considered including soft and hard engineering approaches. Table 12.3.1 below outlines the long list of options that could be implemented to protect the shoreline from the threat of coastal erosion.

Table 12.3.1: Appraisal of long list of options

Strategy Zone	Strategy section	High Level Policy Option	Management Option	Management Period
Zone 1 Northern Portrane Beach	Non- applicable	Dune Management	Annual/periodic maintenance	Short Term
		Dune Management	Annual/periodic maintenance	Medium Term
		Do nothing	Do nothing	Long Term
Zone 2 Middle Portrane Beach	Section 2.1	Dune Management	Dune stabilisation	Short term
		Dune Management: Improve with capital works	Revetment	Short Term
		Dune Management	Annual/periodic maintenance	Medium Term
		Do nothing	Do nothing	Long Term
Zone 2 Middle Portrane Beach	Section 2.2	Dune Management	Dune stabilisation	Short term
		Dune Management: Improve with capital works	Revetment	Short Term
		HTL: Maintain	Annual/periodic maintenance	Medium Term
		Do nothing	Do nothing	Long Term

Strategy Zone	Strategy section	High Level Policy Option	Management Option	Management Period
Zone 3 Southern Portrane Beach	Section 3.1	Dune Management	Dune stabilisation	Short Term
		Dune Management: Improve with capital works	Revetment/encasement/toe protection	Short Term
		Dune Management: Improve with capital works	Sheet piling, cladding and encasement	Short Term
		Dune Management	Annual/periodic maintenance	Medium Term
		Do nothing	Do nothing	Long Term
Zone 3 Southern Portrane Beach	Section 3.2	Dune Management	Dune stabilisation	Short Term
		Dune Management	Annual/periodic maintenance	Medium Term
		Do nothing	Do nothing	Long Term

The long list of potential coastal erosion management options presented in the Table 12.3.1 were then screened to against two initial criteria which were:

- broad costs of both capital and longer term maintenance works
- impact on environment and the likely implications on existing European and National designations.

12.3.1 Options short-listed for Appraisal

Where an option failed to meet either of these criteria, it was rejected. A viable shortlist of options was then produced and presented in Table 12.3.2. The shortlisted options take into account the dynamic stability of the dune system at Portrane beach, which is known to naturally erode during storm events and then recover again during a post-storm recovery period. The shortlisted options are selected in order to manage the dynamic stability of the dune by reducing the vulnerability of the system to erosion during storm events and to catalyse the recovery during the post-storm recovery period.

Table 12.3.2: Short-listed options for appraisal

Strategy Zone	Strategy section	High Level Policy Option	Management Option	Management Period
Zone 1 Northern Portrane Beach	Non- applicable	Dune Management	Annual/periodic maintenance	Short Term
		Dune Management	Annual/periodic maintenance	Medium Term
		Do nothing	Do nothing	Short - Long Term
Zone 2 Middle Portrane Beach	Section 2.1	Dune Management	Dune stabilisation	Short term
		Dune Management	Annual/periodic maintenance	Medium Term
		Do nothing	Do nothing	Long Term
Zone 2 Middle Portrane Beach	Section 2.2	Dune Management	Dune stabilisation	Short term
		Dune Management	Annual/periodic maintenance	Medium Term
		Do nothing	Do nothing	Long Term

Strategy Zone	Strategy section	High Level Policy Option	Management Option	Management Period
Zone 3 Southern Portrane Beach	Section 3.1	Dune Management	Dune stabilisation	Short Term
		Dune Management: Improve with capital works	Revetment	Short Term
		Dune Management	Annual/periodic maintenance	Medium Term
		Do nothing	Do nothing	Long Term
Zone 3 Southern Portrane Beach	Section 3.2	Dune Management	Dune stabilisation	Short Term
		Dune Management	Annual/periodic maintenance	Medium Term
		Do nothing	Do nothing	Long Term

12.4 EVALUATION OF STRATEGIC OPTIONS

On the coastline of Portrane, the linkages between coastal defence and flood protection, coastal processes, habitat diversity and land use are complex. Therefore, a Multi-Criteria Analysis (MCA) was chosen as an objective system to assess the coastal erosion management options that were short-listed in Table 12.3.2 to determine their suitability for each of the respective Zones and sub sections (if applicable). The assessment criteria used in the MCA are presented below:

- **Technical Effectiveness:** An option that effectively manages the risks from coastal erosion and flooding identified in section 10.1 will score highly. Also, an option that requires a low level of mechanical or human intervention will score well. An option that would result in significant adverse effects elsewhere along the shoreline of Portrane will score poorly.
- **Environmental Acceptability:** A good environmental acceptability score for an option comes from likely maintenance of the "favourable" status of key environmental habitats across the majority of the shoreline. Examples of environmental benefits vary. Increased habitat diversity and extent of existing habitats are aspects of an option that will score well. The assessment also needs to consider requirements to maintain European sites in favourable status.
- **Economic:** This criterion will score well if an option minimises the risk of erosion to property and built assets. This criterion will also consider the impacts of options on transport infrastructure, if applicable.
- **Social:** This criterion is difficult to score as stakeholders have diverse needs and opinions depending on their use of the shoreline and backing hinterland. An option that is universally condemned will score low.
- **Other:** This criterion will consider any other aspects that may influence the implementation of any coastal management options, including associated risks and uncertainties. This may include, but is not limited to can change in physical conditions (due to uncertainty in the understanding of coastal processes, unforeseen changes such as accelerated climate change) or political circumstances (e.g. through government guidance/legislation).

The weights assigned to each criterion, and the specific scoring system for each criterion are reflective of those used by the OPW and can be found in *Appendix E*.

The performance of each option relative to defined baseline conditions (the present day) was scored for each of the above-mentioned criterion. Following scoring, for each criterion, a weighted score was then calculated for each option. A total MCA score was then calculated for each criterion as the sum of the weighted scores. All options with a positive MCA score were carried forward to the final stage of the process - identification of the preferred options.

The outputs from the MCA analysis for each Zone and section (if applicable) of Portrane beach are displayed below in figures Table 12.4.1 to Table 12.4.5.

Table 12.4.1: Multi-Criteria Analysis of coastal management options for Portrane Beach, Zone 1

Criteria	Objective	Relative weights	Coastal Management Protection Option			
			Do nothing		Dune Management	
			Score	Weighted Score	Score	Weighted Score
1 Technical Effectiveness	Level of mechanical or human intervention required	5	5	25	3	15
	Health and Safety	5	5	25	4	20
2 Economic	Minimise Economic risk	0	0	0	0	0
	Minimise Risk to Transport Infrastructure	1	-1	-1	1	1
3 Social	Minimise Risk to Health and Life, including properties	0	0	0	0	0
4 Environmental Acceptability	Avoid damage to designated sites of importance	5	0	0	3	15
	Protect landscape character	3	0	0	1	3
5 Other	Other	1	5	5	-1	-1
MCA Weighted Score			54		53	
MCA Score Percentage			54%		53%	

Table 12.4.2: Multi-Criteria Analysis of coastal management options for Portrane Beach, Zone 2 – Section 2.1

Criteria	Objective	Relative weights	Coastal Management Protection Option			
			Do nothing		Dune Management	
			Score	Weighted Score	Score	Weighted Score
1 Technical Effectiveness	Level of mechanical or human intervention required	5	5	25	3	15
	Health and Safety	5	5	25	4	20
2 Economic	Minimise Economic risk	2	-3	-6	3	6
	Minimise Risk to Transport Infrastructure	1	-1	-1	3	3
3 Social	Minimise Risk to Health and Life, including properties	1	-1	-1	3	3
4 Environmental Acceptability	Avoid damage to designated sites of importance	5	0	0	3	15
	Protect landscape character	3	0	0	1	3
5 Other	Other	1	5	5	-1	-1
MCA Weighted Score			47		64	
MCA Score Percentage			41%		55%	

Table 12.4.3: Multi-Criteria Analysis of coastal management options for Portrane Beach, Zone 2 – Section 2.2

		Coastal Management Protection Option				
		Do nothing		Dune Management		
Criteria	Objective	Relative weights	Score	Weighted Score	Score	Weighted Score
1 Technical Effectiveness	Level of mechanical or human intervention required	5	5	25	3	15
	Health and Safety	5	5	25	4	20
2 Economic	Minimise Economic risk	3	-3	-9	3	3
	Minimise Risk to Transport Infrastructure	1	-1	-1	3	3
3 Social	Minimise Risk to Health and Life, including properties	1	-1	-1	2	2
4 Environmental Acceptability	Avoid damage to designated sites of importance	5	0	0	3	15
	Protect landscape character	3	0	0	1	3
5 Other	Other	1	5	5	-1	-1
MCA Weighted Score			44		61	
MCA Score Percentage			37%		51%	

Table 12.4.4: Multi-Criteria Analysis of coastal management options for Portrane Beach, Zone 3 – Section 3.1

Criteria	Objective	Relative weights	Coastal Management Protection Option					
			Do nothing		Dune Management		Capital Works: Revetment	
			Score	Weighted Score	Score	Weighted Score	Score	Weighted Score
1 Technical Effectiveness	Level of mechanical or human intervention required	5	5	25	3	15	-1	-5
	Health and Safety	5	5	25	4	20	-1	-5
2 Economic	Minimise Economic risk	4	-3	-12	1	4	4	16
	Minimise Risk to Transport Infrastructure	1	-1	-1	1	1	5	5
3 Social	Minimise Risk to Health and Life, including properties	1	-1	-1	2	2	4	4
4 Environmental Acceptability	Avoid damage to designated sites of importance	5	0	0	3	15	-5	-25
	Protect landscape character	3	0	0	1	3	-3	-3
5 Other	Other - Future changes	1	5	5	-1	-1	3	3
MCA Weighted Score			41		59		-25	
MCA Score Percentage			33%		46%		-20%	

Table 12.4.5: Multi-Criteria Analysis of coastal management options for Portrane Beach, Zone 3 – Section 3.2

Criteria		Objective	Relative weights	Coastal Management Protection Option				
				Do nothing		Dune Management		
				Score	Weighted Score	Score	Weighted Score	
1 Technical Effectiveness	Level of mechanical or human intervention required	5	5	25	3	15		
	Health and Safety	5	5	25	4	20		
2 Economic	Minimise Economic risk	0	0	0	0	0		
	Minimise Risk to Transport Infrastructure	1	-1	-1	3	3		
3 Social	Minimise Risk to Health and Life, including properties	0	0	0	0	0		
4 Environmental Acceptability	Avoid damage to designated sites of importance	5	0	0	3	15		
	Protect landscape character	3	0	0	1	3		
5 Other	Other	1	5	5	-1	-1		
			MCA Weighted Score		54		55	
			MCA Score Percentage		54%		55%	

12.5 IDENTIFICATION OF THE PREFERRED OPTIONS

The option that had consistent high levels of success against all the criteria was the '**Dune Management**' option. Considering that the Dune system is generally dynamically stable, this option would continue to allow the dune system to naturally erode during storms and then accrete again during the post storm recovery period. The system would be managed as and when required, i.e. the dune would be re-planted in localised areas to protect the fore dunes from significant erosion during storm surges. This measure would also aid the recovery of the fore dune during the post storm recovery period. Existing defences along the coast line, including the sand fencing and marram vegetation would be repaired and subsequently maintained. By adopting the Dune Management option, the natural coastal processes are allowed to continue and a naturally functioning coastline is maintained. Furthermore, European and National objectives are likely to be fulfilled. The preferred policies for each Zone and section (if applicable) to achieve this Plan are provided below

12.5.1 Zone 1, Northern Portrane Beach

Summary of the Plan and Justification

Plan:

The Northern end of Portrane beach marks the extremity of the frontage to be managed. The salt marsh east to dune system is vulnerable to erosion caused by extreme storm events and rises in sea level caused by climate change. The area is of high nature conservation value and landscape value. Considering that no property or built assets are at risk, the long term plan is to Do nothing, this will maintain the important geological and biological interests of the frontage and its landscape quality.

Short Term: As no risks have been identified in this area, the present day policy for the northern end of Portrane beach is to Do nothing. This will maintain the landscape which is of significant environmental importance, holding the European level designations of Special Area of Conservation (SAC) and Special Protection Area (SPA) and national designation of proposed Natural Heritage Area (pNHA). It will also maintain a free functioning shoreline. This policy is consistent with the medium and long term policies.

Medium Term: The medium term policy for the northern end of Portrane beach is to continue allowing natural processes to take place i.e. potential accretion or erosion of the dune system and shoreline under a Do nothing scenario. Rates of erosion are likely to increase slightly during this epoch as a consequence of sea level rise.

Long Term: The long term policy for the northern end of Portrane beach is to adopt the Do nothing option. Despite ongoing sea level rise, erosion and transportation rates along this frontage will remain low. Thus, the general character of this frontage, i.e. one of significant environmental importance, will not alter. The Salt Marsh in this area may eventually disappear due to sea level rise and erosion, but no built assets are threatened, so by adopting a Do nothing approach, natural processes will be allowed to continue.

Table 12.5.1: Implications of coastal management options for Portrane Beach, Zone 1

Time Period	Management Activity	Property and Built Assets	Landscape	Nature Conservation	Amenity and Recreational Use
Short Term (2015)	Do nothing	No built assets are at risk	European and National designations maintained	The continuation of natural processes and naturally function coast maintains biological assets	The current amenity and recreational facilities will be maintained
Medium Term (2050)	Do nothing	No built assets are at risk	European and National designations maintained	The continuation of natural processes and naturally function coast maintains biological assets	The current amenity and recreational facilities will be maintained
Long Term (2100)	Do Nothing	No built assets are at risk	European and National designations maintained. Salt Marsh may be lost.	The continuation of natural processes and naturally function coast maintains biological assets. Salt marsh may be lost	Sea Level rise may reduce the width of the beach in this area

12.5.2 Zone 2 Section 2.1, Middle Portrane Beach

Summary of the Plan and Justification

Plan:

Section 2.1 of Zone 2 in the middle of Portrane beach is of a high nature conservation value and landscape value. Soft engineering solutions that have been implemented in the past are still evident along this section, but no longer effective. This area is considered dynamically stable, and is expected to naturally erode and accrete. Therefore, the short term plan for this area is to stabilise this area by re-planting localised areas of the dune to facilitate the dynamic stability of the dune. In the medium term, it is recommended that the re-planted dune is maintained as long as it remains economically and technically viable to do so. The long term plan is to Do nothing, this will maintain the important geological and biological interests of the frontage and its landscape quality.

Short Term: The present day policy for this area is to stabilise the dune by re-planting the fore dune where the dune face has become over exposed, this will reduce the extent of damage caused if the toe of the dune is eroded by wave action. Any re-profiling undertaken must be followed up by marram planting, seeding, sand trap fencing or, preferably a combination of all three. This will protect assets behind the fore-dune from the risk of erosion and flooding. These measures will also maintain a free functioning shoreline and will likely maintain the existing European level designations of Special Area of Conservation (SAC) and Special Protection Area (SPA) that the landscape currently holds. This policy is consistent with the medium policy.

Medium Term: The medium term policy for this area is to continue to manage the dune through maintenance as and when necessary, as long as it remains economically and technically viable to do so. This will prolong the dune in acting as a defence structure. This will protect the assets behind the fore-dune from the risk of erosion and flooding.

Long Term: The long term policy for this area of Portrane beach is to adopt the Do nothing option. The Do nothing approach is recommended as the dune management option is unsustainable as the cost of the associated works to protect one residential property will become increasingly difficult both economically and technically, it would also impinge on the coastal landscape. Adopting the Do nothing approach would also allow the natural coastal processes along the shore line to continue, increasing the likelihood of retaining the European level designations of Special Area of Conservation (SAC) and Special Protection Area (SPA).

Table 12.5.2: Implications of coastal management options for Portrane Beach, Zone 2 – Section 2.1

Time Period	Management Activity	Property and Built Assets	Landscape	Nature Conservation	Amenity and Recreational Use
Short Term (2015)	Dune Management: Dune Stabilisation	No built assets are at risk	European and National designations likely to be maintained	European and National designations likely to be maintained	The current amenity and recreational facilities will be maintained
Medium Term (2050)	Dune Management: Annual/periodic maintenance	No built assets are at risk	European and National designations likely to be maintained	European and National designations likely to be maintained	The current amenity and recreational facilities will be maintained
Long Term (2100)	Do Nothing	Potential risk to 1 residential property if climate changes at rate predicted by HEFS	Land is lost by a natural coastal landscape is reactivated. European and National designations maintained.	The continuation of natural processes and naturally functioning coast maintains biological assets. European and National designations maintained.	Sea Level rise may reduce the intertidal zone in this area

12.5.3 Zone 2 Section 2.2, Middle Portrane Beach

Summary of the Plan and Justification

Plan:

Section 2.2 of Zone 2 in the middle of Portrane beach is an of high nature conservation value and landscape value. Soft engineering solutions that have been implemented in the past are still evident along this section, but no longer effective. Two residential properties may be at risk from erosion if climate change was to occur as predicted by the HEFS. Therefore, the short term plan for this area is facilitate the dynamic stability of the dune system by managing the dune. This will be achieved by re-profiling the fore dune if necessary and implementing soft engineering defences including sand fencing and the planting of marram. It is suggested that the dune is managed in the medium term by repairing and maintaining the defences already in place. The long term plan is to Do nothing, this will maintain the important geological and biological interests of the frontage and its landscape quality.

Short Term: The present day policy for this area is to stabilise the dune by re-planting the fore dune where the dune face has become over exposed, this will reduce the extent of damage caused if the toe of the dune is eroded by wave action. Any re-profiling undertaken must be followed up by marram planting, seeding, sand trap fencing or, preferably a combination of all three. This will protect assets behind the fore-dune from the risk of erosion and flooding. These measures will also maintain a free functioning shoreline and will likely maintain the existing European level designations of Special Area of Conservation (SAC) and Special Protection Area (SPA) that the landscape currently holds. This policy is consistent with the medium policy.

Medium Term: The medium term policy for this area is to continue to manage the dune through maintenance as and when necessary, as long as it remains economically and technically viable to do so. This will prolong the dune in acting as a defence structure. This will protect the assets behind the fore-dune from the risk of erosion and flooding.

Long Term: The long term policy for this area of Portrane beach is to adopt the Do nothing option. The Do nothing approach is recommended as adopting the dune management option to protect two residential properties will become increasingly difficult both economically and technically, it would also impinge on the coastal landscape. Attempting to manage the dune would likely result in differential erosion along the shoreline. Adopting the Do nothing approach would also allow the natural coastal processes along the shoreline to continue, increasing the likelihood of retaining the European level designations of Special Area of Conservation (SAC) and Special Protection Area (SPA).

Table 12.5.3: Implications of coastal management options for Portrane Beach, Zone 2 – Section 2.2

Time Period	Management Activity	Property and Built Assets	Landscape	Nature Conservation	Amenity and Recreational Use
Short Term (2015)	Dune Management: Dune Stabilisation	No built assets are at risk	European and National designations likely to be maintained	European and National designations likely to be maintained	The current amenity and recreational facilities will be maintained
Medium Term (2050)	Dune Management: Annual/periodic maintenance	No built assets are at risk	European and National designations likely to be maintained	European and National designations likely to be maintained	Sea Level rise may reduce the intertidal zone in this area
Long Term (2100)	Do Nothing	Potential risk to 2 residential properties if climate changes at rate predicted by HEFS	Land is lost by a natural coastal landscape is reactivated. European and National designations maintained.	The continuation of natural processes and naturally functioning coast maintains biological assets. European and National designations maintained.	Sea Level rise may reduce the intertidal zone in this area

12.5.4 Zone 3 Section 3.1, Southern Portrane Beach

Summary of the Plan and Justification

Plan:

Section 3.1 of Zone 3 in the southern end of Portrane beach is of high nature conservation value and landscape value. Soft engineering solutions that have been implemented in the past are still evident along this section, but no longer effective. One residential property (Property D, Figure 10.1.2) is currently at risk if climate change is to occur as predicted by the MRFS. An additional 6 may be at risk from erosion if climate change was to occur as predicted by the HEFS. Therefore, the short term plan for this area is to re-plant the fore dune and replace any existing sand fencing and the planting of marram. The long term plan is to Do nothing, this will maintain the important geological and biological interests of the frontage and its landscape quality.

Short Term: The present day policy for this area is to stabilise the dune by re-planting the fore dune where the localised areas have become over steepened, this will reduce the extent of damage caused if the toe of the dune is eroded by wave action. Any re-profiling undertaken must be followed up by marram planting, seeding, sand trap fencing or, preferably a combination of all three. These measures will also maintain a free functioning shoreline and will likely maintain the existing European level designations of Special Area of Conservation (SAC) and Special Protection Area (SPA) that the landscape currently holds. A longstop could be constructed to protect property D from the immediate risk of coastal erosion. However, it may economically unviable to spend public money on a defence that protects only one private residential dwelling. The construction of such a defence would impact the likelihood of retaining the existing European level designations and interrupt natural coastal processes that would likely result in differential erosion along the shoreline.

Medium Term: The medium term policy for this area is to continue to manage the dune. This will be achieved by maintaining the existing dunes as a defence structure. This will protect the assets, except for property D, from the risk of erosion and flooding in both the MRFS and HEFS. It is likely that if the "long stop" buried defence is not implemented, Property D will be lost during this epoch.

Long Term: The long term policy for this area of Portrane beach is to adopt the Do nothing option. The Do nothing approach is recommended as the Hold the Line option is unsustainable as the cost of maintaining the dune and shoreline to protect 6 residential properties will become increasingly difficult both economically and technically, it would also impinge on the coastal landscape. A dune management option that requires the use of hard engineering solutions is likely to result in differential erosion along the shoreline. Adopting the Do nothing approach would also allow the natural coastal processes along the shoreline to continue, increasing the likelihood of retaining the European level designations of Special Area of Conservation (SAC) and Special Protection Area (SPA).

Table 12.5.4: Implications of coastal management options for Portrane Beach, Zone 3 – Section 3.1

Time Period	Management Activity		Property and Built Assets		Landscape	
	Dune Management: Hard Engineering	Dune Management	Dune Management: Hard Engineering	Dune Management	Dune Management: Hard Engineering	Dune Management
Short Term (2015)	Significantly increase hard engineering practices in front of Property D	Dune Stabilisation	All properties and built assets will be protected	Most assets will be protected. Property D may still be at risk from erosion	Increased engineering has an adverse effect on the land and shore. Current landscape sustained albeit an artificial one. Decreased likelihood of maintaining European and National designations	European and National designations likely to be maintained
Medium Term (2050)	Dune Management		Dune Management		Dune Management	
	Periodic/annual maintenance of defences		Property D may still be at risk depending on rate of climate change and extreme storm events		Land is lost by a natural coastal landscape is reactivated. European and National designations likely to be maintained	
Long Term (2100)	Periodic/annual maintenance of defences		Property D likely to have been lost to erosion. Potential risk to 6 other residential properties if climate changes at rate predicted by HEFS		Land is lost by a natural coastal landscape is reactivated. European and National designations likely to be maintained	

Time Period	Nature Conservation		Amenity and Recreational Use	
Short Term (2015)	Dune Management: Hard Engineering	Dune Management	Dune Management: Hard Engineering	Dune Management
	Increased engineering has an adverse effect on the land and shore. Current landscape sustained albeit an artificial one. Decreased likelihood of maintaining European and National designations	European and National designations likely to be maintained	Current amenity and recreational facilities maintained	Current amenity and recreational facilities maintained
Medium Term (2050)	Dune Management		Dune Management	
	European and National designations likely to be maintained	European and National designations likely to be maintained	Sea Level rise may reduce the intertidal zone in this area	Sea Level rise may reduce the intertidal zone in this area
Long Term (2100)	The continuation of natural processes and naturally functioning coast maintains biological assets. European and National designations maintained.	Land is lost by a natural coastal landscape is reactivated. European and National designations maintained. European and National designations likely to be maintained	Sea Level rise may reduce the width of the beach in this area	Sea Level rise may reduce the intertidal zone in this area

12.5.5 Zone 3 Section 3.2, Southern Portrane Beach

Summary of the Plan and Justification

Plan:

Section 3.2 of Zone 3 in the southern end of Portrane beach is of high nature conservation value and landscape value, although no assets have been identified as being at risk from coastal erosion. The shoreline exposure to incident swell and wave energy originating from the south and south east sectors is also reduced by the geographical location of the headland at Portrane, which acts to shelter this region. Therefore, the short term plan for this area is to manage the system by planting marram and constructing sand fences. The medium term plan is to continue to maintain and repair these defences as when required. The long term plan is to Do nothing, this will maintain the important geological and biological interests of the frontage and its landscape quality.

Short Term: The present day policy for this area is to manage the system. This can be achieved by building areas up with sand, planting marram and protecting the vegetation until it becomes established in regions where necessary. These measures will also maintain a free functioning shoreline, mitigate impacts of climate change on tourism and will likely maintain the existing European level designations of Special Area of Conservation (SAC) and Special Protection Area (SPA) that the landscape currently holds.

Medium Term: The medium term policy for this area is to continue to manage the system. This will be achieved by the continued maintenance and repair of existing defences as and when required. A narrowing of the intertidal area may occur during this epoch.

Long Term: The long term policy for this area of Portrane beach is to adopt the Do nothing option. The Do nothing approach is recommended as maintaining the system would be unsustainable as no assets are have been identified as being at risk. Adopting the Do nothing approach would also allow the natural coastal processes along the shoreline to continue, increasing the likelihood of retaining the European level designations of Special Area of Conservation (SAC) and Special Protection Area (SPA).

Table 12.5.5: Implications of coastal management options for Portrane Beach, Zone 3 – Section 3.2

Time Period	Management Activity	Property and Built Assets	Landscape	Nature Conservation	Amenity and Recreational Use
Short Term (2015)	Dune Management: Dune Stabilisation	No built assets are at risk	European and National designations likely to be maintained	European and National designations likely to be maintained	The current amenity and recreational facilities will be maintained
Medium Term (2050)	Dune Management: Annual/periodic maintenance	No built assets are at risk	European and National designations likely to be maintained	European and National designations likely to be maintained	The current amenity and recreational facilities will be maintained
Long Term (2100)	Do Nothing	No built assets are at risk	European and National designations likely to be maintained	The continuation of natural processes and naturally functioning coast maintains biological assets. European and National designations maintained.	Sea Level rise may reduce the intertidal zone in this area

12.6 SPECIFICATION OF PROPOSED OPTIONS

12.7 SOFT ENGINEERING: SAND TRAP FENCING

Sand trap fencing is a long-established method of “soft engineering” that aids in the accumulation of wind-blown sand on a dune face. The technique has been extensively researched and refined and a detailed methodology for the successful design and installation of this type of measure in Ireland is described in the ECOPRO manual (Government of Ireland, 1996).

12.7.1 General

The effect of installing sand-trap fencing is to break the natural flow of sand within the dune transport system. Moving sand is vital for the health of sand dune vegetation. However, for vegetation to be established a degree of stability is required. This can be achieved by constructing sand trap fencing.

Where there is across-shore aeolian sand movement there is scope for sand-trap fencing. Where human interference has damaged foredunes, sand-trap fencing can repair this damage and facilitate a return to a state of equilibrium. The sand may be trapped and dispersed seasonally or it may lead to a long term build-up. In both cases there is a beneficial effect. The sand built up and dissipated seasonally becomes part of the active transport system that plays a fundamental role in coastal protection. Sand accumulated over the long-term remains available to the sand transport system for the future.

The actual trapping mechanism involves fixing a barrier with a 40-50% porosity about 1.25m on the windward side of where sand build up is required.

Vulnerable foredunes can be protected by encouraging the seasonal development of embryo dunes using sand trap fencing. Although they will be swept aside by winter seas (a useful measure of protection will nonetheless have been afforded to the fore dune and net losses will be reduced. Excessive pedestrian traffic can cause serious fore dune breaks resulting in the formation of active blowouts. Sand-trap fencing will help repair this damage without upsetting the dynamics of the system.



Figure 12.7.1: Sand trap fencing being employed successfully at Co. Clare



Figure 12.7.2: Sand trap fencing damage following typical winter storm event Co. Clare

12.7.2 Fencing Details

12.7.2.1 Natural materials

Chestnut paling makes functional and attractive sand trap fencing. The temptation to use locally available timber offcuts should be avoided as these are likely to generate splinters and loose staples which pose a hazard to beach users. Chestnut paling has previously been used for the fencing which is already present at the site (see Figure 5.1.5).

12.7.2.2 Man-made materials

Although many synthetic meshes are available, snow fencing is one of the most successful. It is available in rolls 1m high and 30m long. This height is quite suitable as most sand is trapped within 1m from the ground. Green coloured snow fencing has been used, in combination with chestnut palings, in the example given in Figure 12.7.1 and Figure 12.7.2

12.7.3 Fencing Design

It can be seen in Figure 5.5 in Section 5.1 that chestnut fencing has been erected along some of the eroding areas at the south end of Portrane beach. However, this fencing appears to have had limited effect in accumulating sand and has been damaged by one or more storms.

According to ECOPRO, best results are achieved if sand fencing is aligned at right angles to the prevailing wind. A wind rose for the nearby Dublin Airport is shown in Figure 12.7.3. It can be seen that the dominant wind direction is from the west to south west sectors.

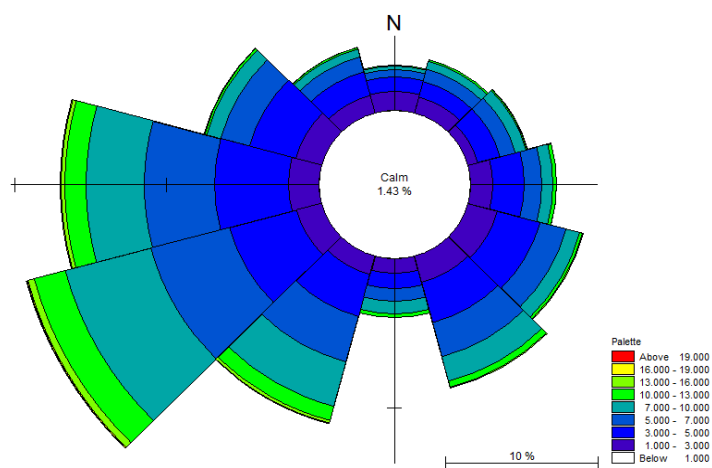

Figure 12.7.3: Wind Rose for Dublin Airport

ECOPRO recommends that the fencing should be installed initially at the downwind end of the dunes. As sand accumulates additional lines of fences can be installed. Later the new dune can be heightened by adding fences on top of those originally installed. Initially it is unlikely that more than two lines of fences will be required, these are spaced $4h$ apart, where h is the fence height. The fence is placed about 1.25m in front of where maximum accumulation is required. These recommendations made by ECOPRO are summarised in Figure 12.4.

Where winds are co-dominant or where a significant element runs at right angles to the predominant direction then a transverse or zig-zag array of fences ought to be considered. These transverse fences are spaced 6h apart (see Figure 12.7.4). An examination of local conditions is advisable before choosing a precise pattern.

Once in place it will be necessary to fence off the project site from amenity access. Use sheep wire fencing or chestnut paling and attach attractive-looking signs describing the work in hand and the importance of public support for its success.

When sand accumulations are consolidating, consideration ought to be given to planting with marram. Start by planting the leeward side, working round to the windward. Regular monitoring is required especially where high accumulations are expected. Where embryo dune formation has been facilitated annual maintenance is likely to be necessary.

12.7.4 Potential Problems

Sand trap fencing that is only partially effective will protrude above the sand surface. It may become a serious hazard to the public especially in high amenity areas. Where this is likely, it is wise to erect temporary access control fencing when required. This does require an extra commitment on behalf of the local authority but it is likely to be very well worthwhile. (The permanent or semi permanent posts needed to support this fencing will be 1.5 m high and will not constitute a risk to the public.)

An alternative strategy is to confine sand trap fencing to self-supporting brushwood. In this case, do not use custom-made fencing.

12.7.5 Environmental impacts and opportunities

Sand trap fencing can lead to significant sand build-up, seasonal or otherwise. Serious environmental impacts can result from the over-planting of these dunes by reducing the amount of sand available for the local sand budget.

Well-sited fences repair damage caused by excessive amenity pressures. Fencing can also reduce the trampling of vegetation along the edge of dunes. Fencing and associated vegetation transplanting can help to stabilise the fore dunes and can extend the dune habitat.

12.7.6 Costs

Fencing costs vary according to labour, type of material used, quality, length and spacing of posts, frequency of spurs, frequency of public access points and the cost of ancillary works. Small schemes in low risk areas may be implemented by volunteers and may cost less than €600/100m frontage. Contracted schemes involving fenced access routes and substantial straining piles may push costs up to €20,000/km, plus ongoing maintenance. Well constructed fences in appropriate locations should have a 5 year life.

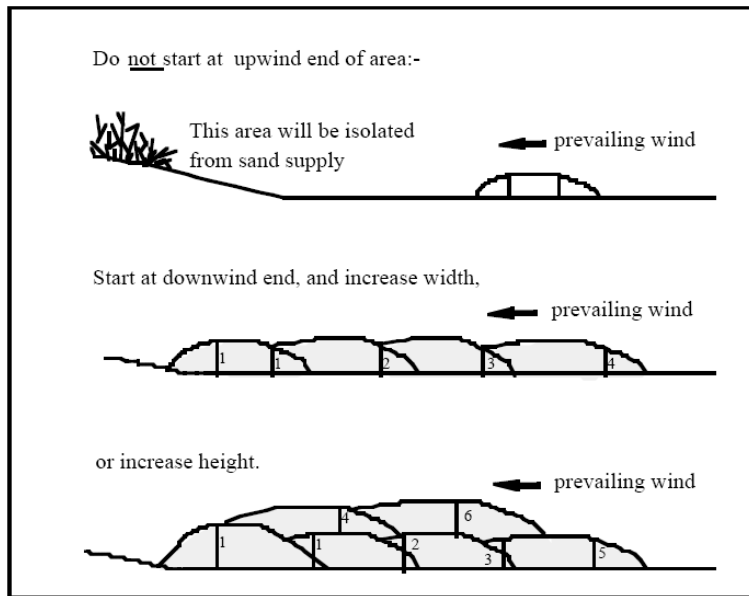

Fig. A4.16 - Progressive build-up of sand using fencing

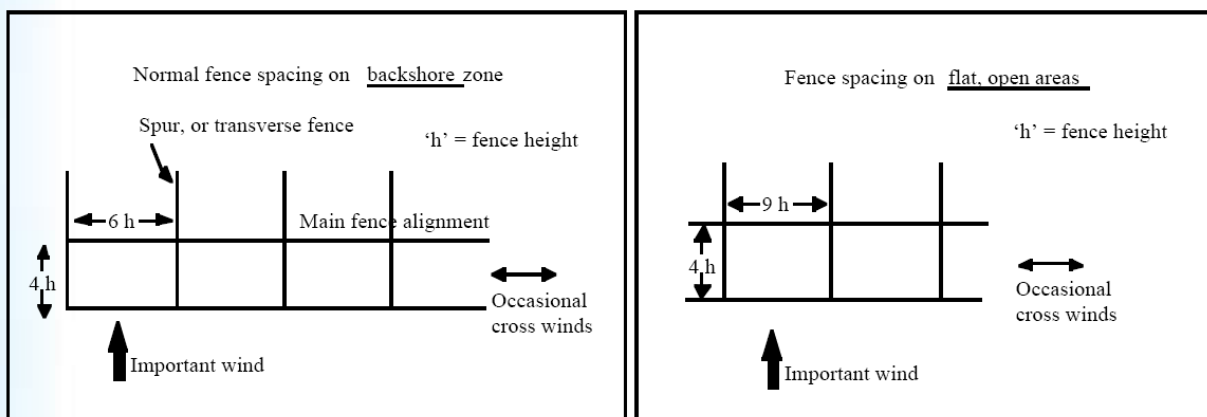

Fig. A4.17 - Spacings for sand trap fencing

Figure 12.7.4: Sand trap fencing design recommendations from ECOPRO Manual

12.8 SOFT ENGINEERING: DUNE REPROFILING AND MARRAM PLANTING

12.8.1 General

Where dune faces have become over-steepened through dune toe erosion or through a continual lowering of beach levels over many years it can be difficult to acquire and retain a reasonable vegetation cover.

Steep dunes will be continuously vulnerable to undercutting by wave action; resulting in failure and slumping of the upper dune face (see Figure 12.8.1).



Figure 12.8.1: Over steepened dunes, southern Portrane beach

Re-profiling the dune to a more stable slope angle (usually around 1 in 2.5) will reduce the extent of damage caused if the toe of the dune is eroded by wave action. Reprofiling must be followed up by marram planting, seeding, sand trap fencing or, preferably a combination of all three.

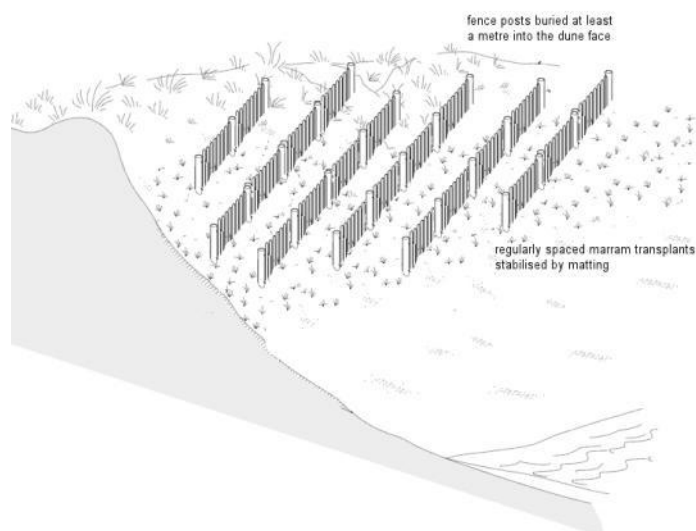

Figure 12.8.2: Sketch of typical marram planting and fencing

If the dune being re-profiled is vegetated, the plants can be removed ahead of the works and temporarily stored nearby. Then, when re-profiling is complete, the plants can be replaced en masse or separated into small plantlets for coverage of a wider area. If there is not enough vegetation remaining on the dunes to be re-profiled for satisfactory coverage post works, marram can be transplanted from other, more stable, areas of the dune using ECOPRO Technique 18.

With exposed dunes that are due to be planted with marram, it is necessary to protect the surface from windblow immediately after re-profiling. This can be achieved either by spraying with a tackifier, or by covering with a simple hessian or jute matting before planting. The installation of access control fencing is equally important.

A typical strategy that has been employed with good success at a site in Co. Clare has been to plant marram clumps, approximately two inches square, at staggered intervals roughly 45-50 cm apart on the dune face, through small slits cut into biodegradable hessian matting which is affixed to the bare dune face with wooden pegs. Alternatively, u-shaped steel fixings approximately 2.5 feet in length can be used. However, these should be removed once the matting/vegetation has stabilised. The marram rapidly spreads through the matting, strengthening the dune face and encouraging further accretion of sand. These recommendations are summarised in Figure 12.8.2.

Whether a system is accreting or depleting, dune reprofiling will often involve a reduction in the overall dune height and a “setting back” of the dune crest. This may lead the public to fear that their dunes are being put at greater risk and therefore it is important to keep stakeholders well informed of the overall aims of the works.

ECOPRO recommends that full use ought to be made of attractive signs to reassure the public and encourage them to take responsibility for their dunes. This approach also helps reduce vandalism.

12.8.2 Environmental impacts and opportunities

Sand deposited on the upper beach may be subject to wind erosion, causing unwanted increase in blown sand across the back shore. The deposits may also burrow existing vegetations and intertidal invertebrate communities, reducing the natural stability of the fore dunes and destroying habitats. Re-profiling may also destroy the local dune habitat, land form and landscape.

Re-profiling will enhance the natural recovery of dune face erosion and provide a wider recreational beach. The initial artificial appearance of the upper beach and dune face will quickly be transformed predominantly by wind, but also wind, waves and vegetation to a more natural form.

12.8.3 Costs

The costs for dune reprofiling is low to moderate, but requires ongoing maintenance. Costs can vary between €1,000 and €20,000/100m length plus fencing, grass planting with similar repeat costs after extreme storm events.

12.9 SOFT ENGINEERING: PERIODIC MAINTAINCE OF DEFENCES

This option involves the monitoring and the subsequent maintenance of the dune vegetation along the shoreline. Maintenance may be carried out annually or periodically. It is recommended that maintenance work should be made after extreme storm events.

It is likely that after extreme storm events, localised areas may need to be completely re-planted and re-fenced. In this instance the initial capital cost of implementing the original defences will have to be re-spent in order to continue to manage the dune.

12.10 HARD ENGINEERING: REVETMENT AND BURIED “LONG STOP”

12.10.1 Revetments

Revetments are frequently used to protect shorelines from coastal erosion. These structures may be formed from rock armour or concrete or natural stone blocks and are normally only used when there are important assets that must be protected from erosion under all conditions.

Apart from the high cost, the major problem with the use of revetment in a beach dune environment is that the revetment destroys the natural dune beach interaction. Unless the area is naturally accreting, in which case the revetment will eventually become buried, the revetment will prevent the dunes supplying sand to the upper beach during storm conditions with the result that there will be a tendency for the beach levels to decline with time.

12.10.2 Buried Long stop

A particular form of revetment called a “long stop” can be used as part of a beach management system to protect valuable assets during times of extreme storms. The “long stop” is buried within the dune structure sufficiently far behind the face of the dunes so that it only gets exposed during extreme storm events typically with return period of 1 in 50 years or more. For all lesser events the structure remains buried and does not interfere with the natural dune/beach processes. If the long stop gets exposed during an extreme event it holds the line until after the storm when the dune must be rebuilt to reinstate the naturally beach/dune relationship.

The buried long stop works well on dynamically stable dune systems but have a limited lifespan on retreating shoreline as the structure must be removed once the coastline has generally retreated to the line of the long stop. A drawing of a longstop protecting a property located close behind the dune line is shown in Figure 12.10.1

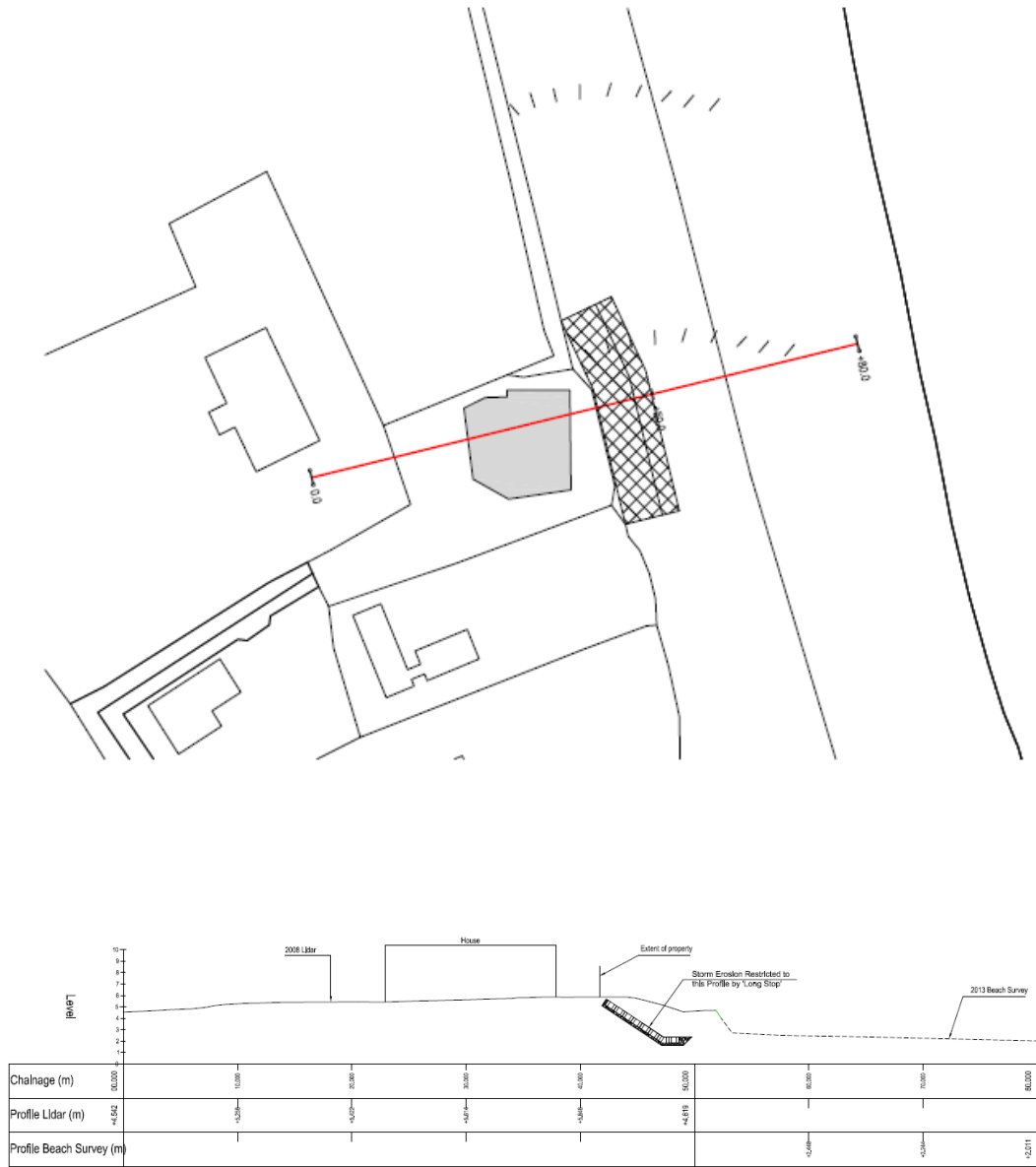

Figure 12.10.1: Buried “Long Stop” installed to protect a property behind the dune line.

13 ECONOMIC ASSESSMENT

13.1 INTRODUCTION

13.1.1 General approach.

The economic appraisal is based on the latest Flood and Coastal Risk Management Appraisal Guidance (FCERM) (EA,2100), which provides guidance on the methodology to undertake effective assessments. The guidance assists in considering economic benefits and losses that arise from particular options. The economic assessment also includes information from the HM Treasury Green Book (2011) and the Multi-coloured Manual (Middlesex University, 2010). It should be noted that the economic appraisal was undertaken using the treasury guidance specified in FCDPAG3.

The economic appraisal considers the value of the short listed strategy options and whether investment in any of the short listed options is worthwhile. Benefit cost analysis provides a framework for assessing the advantages and disadvantages of the short listed options by expressing all of the potential effects and benefits of an option in terms of monetary cost. An option is considered to be 'justified' if the benefits outweigh the costs.

The 'Do nothing' option is the baseline against which all other options are assessed and is required when undertaking economic assessment of the options. Adopting a 'Do nothing' approach would mean the cessation of all maintenance and capital works. This is often an unrealistic theoretical scenario used as a baseline for evaluation purposes across the wider benefit cost assessment. This allows comparison and contrasting of the costs of doing something against the benefits arising from doing something; all costs are presented in terms of (€) Euro values. To ensure a consistent approach between options, it is important that any 'negative costs' should be regarded as benefits and any 'negative benefits' should be considered as costs.

13.1.2 Discounting

The Present Value (PV) of the future euro is assumed to fall away through time. To include this in the benefit cost ratio the discount factor provided in the HM Treasury Green Book (2011) is applied. The long term discount rates are included in the benefit cost ratio analysis to allow the uncertainty of the future to be included. This uncertainty is shown to cause a decline in discount rates over time. HM Treasury Green Book recommended that for benefit cost analysis that accrues for more than 30 years the following discount rates should be used:

- 3.5% (0 to 30 years)
- 3% (30 to 75 years)
- 2.5 (75 to 100 years)

13.2 BENEFITS

Option benefits have been calculated using the Multi-Coloured Manual (MCM, 2010) over a 100 year period, with benefits discounted in accordance with the HM Treasury Green Book. The price date for the benefits is the same as for the costs. The benefits (from erosion losses) for the benefit cost analysis are calculated from the value of the properties, tourism, historic assets and other infrastructure that are affected by predicted erosion (under a 'Do nothing' scenario) during the 100 year Strategy timescales. However, the only benefits (from erosion losses) applicable to Portrane beach are those stemming from the property. Property benefits.

The future scenario coastal change maps presented in section 9 under the HEFS, indicate that a total of 10 properties across all three Zones are likely to be lost by 2100. The year that each of the properties identified as being at risk from coastal erosion is likely to be lost due to erosion is presented in Table 13.2.1 below. The calculations used assumed that the sea level continues to rise linearly to +1.0m by 2100, as predicted by the HEFS.

Table 13.2.1: Predicted year of losses of properties at risk from erosion, assuming HEFS climate changes.

Zone	Section	Property	Current distance from Vegetation Line (m)	Year likely to be Lost
Zone 2 Middle Portrane Beach	2.1	A	44	73
	2.2	B	27	42
		C	45	74
Zone 3 Southern Portrane Beach	3.1	D	19	27
		E	39	63
		F	46	76
		G	48	80
		H	41	67
		I	45	74
		J	50	83

The values of value of a detached residential property was based on a local property tax valuation guide issued by the Irish Tax and Customs office and the recent market prices of detached residential property in the Portrane. From this data the value of a private detached residential dwelling area was estimated to have a present market value of between €339,000 and €350,000. The sum of the values of properties that were affected by erosion during each year from Year 0 were calculated and entered into the FCERM - AG spreadsheet (EA, 2012) for each specific year that additional losses occurred. The discount rate was then applied to each year to determine the Present Value (PV) of the properties lost to erosion. This enabled RPS to determine the benefit gained from implementing any coastal management option, this data is presented in Table 13.2.2.

Several assumptions were made in the assessment of property losses due to coastal erosion:

- as minimum of 4m was assumed from the edge of the vegetation line before the property was deemed uninhabitable.
- where properties had gardens, a judgement was made assuming a property value accounts for the garden also. However, for properties with particularly long gardens, erosion was allowed to proceed for several metres into the garden before the property loss was accounted for.

Table 13.2.2: Calculation of asset losses and benefits of a proposed protection scheme

Property	Market value of asset	Year of loss without protection scheme	Without Scheme		With a Scheme		PV benefit of scheme
			PV asset value	PV asset losses	PV asset value	PV asset losses	
A	350000	73	309,547 €	40,453 €	315,105 €	34,895 €	5,558 €
B	350000	42	248,864 €	101,136 €	262,759 €	87,241 €	13,895 €
C	350000	74	310,725 €	39,275 €	316,121 €	33,879 €	5,396 €
D	350000	27	211,746 €	138,254 €	233,594 €	116,406 €	21,848 €
E	350000	63	295,635 €	54,365 €	303,104 €	46,896 €	7,469 €
F	350000	76	296,414 €	53,586 €	302,637 €	47,363 €	6,224 €
G	350000	80	301,453 €	48,547 €	307,092 €	42,908 €	5,638 €
H	350000	67	301,697 €	48,303 €	308,333 €	41,667 €	6,636 €
I	350000	74	310,725 €	39,275 €	316,121 €	33,879 €	5,396 €
J	350000	83	304,920 €	45,080 €	310,156 €	39,844 €	5,236 €
Total Benefit of scheme							83,297 €

13.3 COSTS

The Present Value costs of the short listed options were determined by combining the capital and maintenance costs. Costs have been estimated and optimised using recent costs of similar works.

13.3.1 Initial capital costs

The initial capital costs for the schemes are presented in Table 13.3.1. The cost of the Dune Stabilisation option was estimated as €55.00 per metre and includes the re-profiling of the dune, the planting of marram and also the construction of sand fencing. The Cost of the revetment was estimated as €200.00 per metre.

Table 13.3.1: The initial capital costs of the proposed management options

Strategy Zone	Strategy section	High Level Policy Option	Length of Defence	Cash Cost (€)
Zone 2 Middle Portrane Beach	Section 2.1	Dune Management: Dune Stabilisation	296	16,280
Zone 2 Middle Portrane Beach	Section 2.2	Dune Management: Dune Stabilisation	348	19,140
Zone 3 Southern Portrane Beach	Section 3.1	Dune Management: Dune Stabilisation	296	16,280
		Hard Engineering: Revetment	40	104,600
Zone 3 Southern Portrane Beach	Section 3.2	Dune Management: Dune Stabilisation	291	16,005
Total Cost Including Revetment (€)				172,305
Total Cost Excluding Revetment (€)				16,280

13.3.2 Annual and Periodic Maintenance

It has been anticipated that the dune management options will have to be fully undertaken every 10 years, until it becomes economically and technically unviable to do so. Also the proposed maintenance costs have only been estimated for the next 50 years, as the preferred management options for shoreline proposes that nothing is done after the medium term (2050). The initial annual and periodic maintenance costs for the schemes are presented in Table 13.3.2.

Table 13.3.2: The assumed capital maintenance costs of the proposed management options

Strategy Zone	Strategy section	High Level Policy Option	Unit periodic maintenance (€)(assumed every 10 years as worst case scenario)	Cash Cost (€)
Zone 2 Middle Portrane Beach	Section 2.1	Dune Management: Dune Stabilisation	296	36,539
Zone 2 Middle Portrane Beach	Section 2.2	Dune Management: Dune Stabilisation	348	42,958
Zone 3 Southern Portrane Beach	Section 3.1	Dune Management: Dune Stabilisation	296	36,539
		Hard Engineering: Revetment	40	5,965
Zone 3 Southern Portrane Beach	Section 3.2	Dune Management: Dune Stabilisation	291	16,005

13.3.3 Annual and Periodic Maintenance

The total capital costs for each scheme are presented in Table 13.3.3 along with the calculated Present value costs.

Table 13.3.3: A summary of options total Present Value (PV) Costs including maintenance.

Strategy Zone	Strategy section	High Level Policy Option	Initial Implementation PV Capital (€)	Future Maintenance Costs (€)	Total PV Cost (€)
Zone 2 Middle Portrane Beach	Section 2.1	Dune Management: Dune Stabilisation	16,280	36,539	52,819
Zone 2 Middle Portrane Beach	Section 2.2	Dune Management: Dune Stabilisation	19,140	42,958	62,098
Zone 3 Southern Portrane Beach	Section 3.1	Dune Management: Dune Stabilisation	16,280	36,539	52,819
		Hard Engineering: Revetment	104,600	5,965	110,565
Zone 3 Southern Portrane Beach	Section 3.2	Dune Management: Dune Stabilisation	16,005	35,922	51,927

13.3.4 Benefit cost ratios

In order to compare the different options, it is useful to consider the benefit cost ratio for each Strategy Zone and section (if applicable). The benefit cost ratio compares the cost of each option (including design, build and ongoing maintenance), against the benefits properties that are not eroded or flooded over a 50 year period.

It should be noted that benefits stemming from tourism and the European and national environmental designations have not been accounted for, as it difficult to quantify the financial benefits gained from either of these drivers. Therefore, it is reasonable to assume that these drivers will increase the financial benefits of any of the identified option(s) and measure(s), resulting in a BCR for the option(s) that is marginally higher than those presented in Table 13.3.4. These unaccounted financial benefits should be considered when deciding upon a final coastal protection management plan.

Table 13.3.4: Benefit cost ratios for each Strategy Zone and Section

Strategy Zone	Strategy section	High Level Policy Option	Initial Implementation PV Capital (€)	Future Maintenance Costs (€)	Total PV Cost (€)	PV Benefits (€)	Average BCR
Zone 2 Middle Portrane Beach	Section 2.1	Dune Management: Dune Stabilisation	16,280	36,539	52,819	5,558	0.11
Zone 2 Middle Portrane Beach	Section 2.2	Dune Management: Dune Stabilisation	19,140	42,958	62,098	19,291	0.31
Zone 3 Southern Portrane Beach	Section 3.1	Dune Management: Dune Stabilisation	16,280	36,539	52,819	58,447	1.11
		Hard Engineering: Longstop	104,600	5,965	110,565	58,447	0.53
Zone 3 Southern Portrane Beach	Section 3.2	Dune Management: Dune Stabilisation	16,005	35,922	51,927	0	0.00

14 CONCLUSIONS AND RECOMMENDATIONS

14.1 CONCLUSIONS

14.1.1 Historical Review

A review of historical aerial photographs from 1973 to 2013 has been undertaken to gain insight into the evolution of the Portrane and Rush beaches. From this review it is evident that both beaches have experienced episodes of both erosion and accretion over the course of the last 40 years. This is considered to be “normal” in a stable dynamic beach-dune system that moves in response to changes in prevailing weather conditions.

The evidence from historical records shows that Portrane beach has been subject to both accretion and erosion over the past 40 years. Previous studies and historical aerial photography have highlighted the changes of the coastline and also the movement of the beach vegetation line over the years. In a previous study carried out by Kirk McClure Morton in 1998, the southern and central zones of Portrane indicated signs of accretion while the northern zone experienced continuous erosion. Today, the opposite is occurring, whereby the northern zone is accreting and the central and southern zones are eroding back to its original location as seen in the 1973 aerial photograph. Unfortunately, over the years development of residential housing has occurred within the central and southern zones. This has become a problem for the residents because accelerated erosion has caused the depletion of the sand dunes resulting in the sea getting closer to the private dwellings.

The western zone of Rush beach has experienced significant changes over the past 40 years, the most obvious is the change in land use from horticultural to residential between 1973 and 1995. The vegetation line has remained relatively stable since 1995 although some localised erosion has occurred in places between 2009 and 2013. In the eastern zone of Rush, gradual accretion of the beach has occurred with the vegetation line moving steadily south. The accretion is most pronounced at the eastern end of the beach where the vegetation line has moved more than 50 metres southwards between 1973-2013.

The historic review has accentuated the fact that although there has been movement of the dunes and vegetation lines on both the Portrane and Rush coastlines, the recent erosion has not caused the vegetation line to retreat any further west than that seen in previous years.

14.1.2 Coastal Processes

The beach and dunes at Portrane and Rush are exposed to storms from the north east to south sectors. As a result of wave refraction, the wave climate that approaches the beaches is predominantly from the south easterly direction, although storms from the north east are present from time to time. The littoral currents and longshore sediment drift tends to move sand in the middle and lower beach in a north westerly direction during south and south easterly wave conditions and in a south westerly direction during north easterly wave conditions. The longshore drift tends to be in a northerly direction along the upper Portrane beach during the majority of wave events with sediment being fed on to the upper beach at the southern and middle sections of the beach. The sediment drift on the upper Rush beach tends to be in a westerly direction along the western section of this beach and is fairly neutral at the eastern section of the Rush beach. Aeolian transport is predominantly from a southerly sector resulting in beach accretion along the eastern half of the Rush beach.

The dunes erosion on both beaches is a result of a combination of high wave activity and storm surge activity that occurs during south and southerly storms. The amount of dune erosion is directly related to the height of high water levels that occurs during the storm. Storms with large surges that occur at times of high spring tides are particularly damaging with significant dune erosion occurring over a short period of time. Over time the dunes have the capacity to regenerate, although this can take several years in the case of damage resulting from a major storm event - particularly if there are significant areas of the dunes with steep exposed sand faces.

14.1.3 Impact of Climate Change

The impact of climate change is expected to result in sea level rise of between 0.5 to 1.0m by 2100. With rising sea levels, the stable dune shore line will tend to erode so as to maintain the balance of water depth and wave climate at the toe of the dune. The dunes along the Portrane beach are expected to recede westward by between 24 to 48 metres by 2100 depending upon the degree of sea level rise. This dune recession is likely to threaten up to 10 properties by 2100.

The dune line along the western section of the Rush beach is expected to recede by 15 to 30 metres by 2100, but little or no recession is expected at the eastern end of the beach due to continued accretion in this area. No properties behind the Rush beach are expected to be threatened by coastal erosion resulting from the currently predicted sea level rise by 2100.

14.1.4 Environmental Designated Areas

The beaches and dunes at Portrane and Rush are designated as both an SAC and SPA and the dunes and the wetlands are on the list of the qualifying interests. The conservation objectives include shifting and fixed dunes so manmade structures that might interfere with the natural dune beach processes are extremely unlikely to comply with the requirements of the EU Habitats Directive. It was considered that the use of dune management systems would be in line with the conservation objectives for the Natura 2000 site areas.

14.1.5 Option and Feasibility Assessment

As the study indicated that there are no assets (either physical or environmental) at risk from coastal erosion behind the Rush beach dune system the proposed policy for this beach is one of no intervention. Thus, there are no option proposals for the Rush beach frontage recommended in the study.

There are properties behind the dunes along the southern and central section of the Portrane beach so an option assessment was undertaken for this beach based on the system commonly used in the UK Shoreline Management Plans. This system includes examining policies and schemes for "Holding the Line", "Advance the Line", "Managed Retreat" and "Do Nothing". In this study the "Managed Retreat" option included dune management systems that would dampen the rate at which the dune line would fluctuate with individual storms without preventing dune recession in response to overall climate change.

The feasibility of various options was assessed in the short, medium and long term both in terms of the cost benefit and environmental impact. The protection of the dunes by placing revetments along the toe of the dune line or the use of other beach structures to hold the line was found to be neither cost effective nor environmentally acceptable. The use of buried longstops, which would give the properties protection from extreme storm erosion, would extend the life of properties for a while until the overall dune erosion due to climate change made the use of the houses untenable. However, the cost benefit of such structures was found to be well below 1 and thus the long stops were not considered to be viable.

The use of dune management schemes that dampen the rate at which the dune line would fluctuate with individual storms were found to be cost effective in extending the life of the properties at risk at Portrane. However, even with such schemes in place, one property will be lost to erosion in the medium term. If sea level rise due to climate change proceeds as predicted by the High End Future Scenario then a further 10 properties will be lost due to erosion before 2100. With the dune management scheme in place these properties are predicted to be safe under Medium Term Future Scenario sea level rise up to 2100.

Overall the use of the dune management system was found to be slightly financially beneficial and environmentally acceptable for the Portrane dune frontage.

14.2 RECOMMENDATIONS

It is recommended that a dune management system including dune re-profiling, matting and planting in conjunction with sand fencing is put in place along the eroded part of the central and southern sections of the Portrane dunes where significant erosion has occurred in recent times. A policy of no intervention is recommended for Rush beach frontage.

As the beaches are designated under the European Habitat Directive, discussions and agreement with NPWS will be required prior to the commencement of any works.

15 REFERENCES

- DEFRA / Environment Agency** (2005) *Use of Joint Probability Methods in Flood Management: A Guide to Best Practice*.
- Department for Environment, Food and Rural Affairs** (2004) *Flood and Coastal Defence Project Appraisal Guidance, FCDPAG3 Economic Appraisal, Supplementary Note to Operating Authorities*.
- Dublin Regional Authority and Mid-East Regional Authority** (2010) *Regional Planning Guidelines for the Greater Dublin Area 2010-2022*.
- Environment Agency** (2010) *Flood and Coastal Erosion Risk Management appraisal guidance*. Environment Agency, Bristol.
- Fingal County Council** (2010) *Fingal County Development Plan 2011-2017*.
- Flood Hazard Research Centre, Middlesex University** (2010) *The benefits of flood and coastal risk management: A handbook of assessment techniques 2010*.
- Goodwillie, R.; Fahy, E.** (1973) *A Preliminary Report on Areas of Scientific Interest in County Dublin*.
- Goodwillie, R.; Ni Lamhna, E.; Webb, R.** (1988) *A Second Report on Areas of Scientific Interest in County Dublin*.
- Government of Ireland** (1996) *Environmentally Friendly Coastal Protection (ECOPRO) Code of Practice*.
- Government of Ireland** (2001) *National Spatial Strategy for Ireland 2002-2020*.
- Government of Ireland** (2007) *National Development Plan (Transforming Ireland – A Better Quality of Life for All), 2007-2013*.
- HM Treasury** (2003) *The Green Book. Appraisal and Evaluation in Central Government*.
- Kirk McClure Morton** (1998) *The Burrow Portrane Coastal Study*.
- McCorry, M.; Ryle, T.** (2007) *Saltmarsh Monitoring Project 2006*.
- McCorry, M.; Ryle, T.** (2009) *Saltmarsh Monitoring Project 2007-2008, Volume 2*.
- McCorry, M.; Ryle, T.** (2009) *Saltmarsh Monitoring Project 2007-2008, Volume 3*.
- National Parks and Wildlife** (2013b) *Rogerstown Estuary SAC (site code 208) Conservation Objectives supporting document - coastal habitats*.
- National Parks and Wildlife** (2013c) *The Status of EU Protected Habitats and Species in Ireland. Habitat Assessments Volume 2, Version 1.0*.

National Parks and Wildlife (2013d) *Conservation Objectives: Rogerstown Estuary SPA 004015. Version 1.*

National Parks and Wildlife (2013e) *Rogerstown Estuary SPA (site code 4015) Conservation Objectives supporting document.*

National Parks and Wildlife Service (2013a). *Conservation Objectives: Rogerstown Estuary SAC 000208. Version 1.0.*

OPW, ICPSS, Phase 3, Work Packages 2, 3 & 4A (2010) *Strategic Assessment of Coastal Flooding and Erosion Extents – North East Coast - Dalkey Island to Omeath.*

OPW, Irish Coastal Wave & Water Level Modelling Study (2013 unpublished). *Coastal Areas Potentially Vulnerable to Wave Overtopping.*

Ryle, T.; Murray, A.; Connolly, C.; Swann, M. (2009) *Coastal Monitoring Project 2004-2006.*